Stream: Internet Engineering Task Force (IETF)
RFC: [9284](#)
Category: Informational
Published: August 2022
ISSN: 2070-1721
Authors: M. Boucadair T. Reddy.K W. Pan
Orange Nokia Huawei Technologies

RFC 9284

Multihoming Deployment Considerations for DDoS Open Threat Signaling (DOTS)

Abstract

This document discusses multihoming considerations for DDoS Open Threat Signaling (DOTS). The goal is to provide some guidance for DOTS clients and client-domain DOTS gateways when multihomed.

Status of This Memo

This document is not an Internet Standards Track specification; it is published for informational purposes.

This document is a product of the Internet Engineering Task Force (IETF). It represents the consensus of the IETF community. It has received public review and has been approved for publication by the Internet Engineering Steering Group (IESG). Not all documents approved by the IESG are candidates for any level of Internet Standard; see Section 2 of RFC 7841.

Information about the current status of this document, any errata, and how to provide feedback on it may be obtained at <https://www.rfc-editor.org/info/rfc9284>.

Copyright Notice

Copyright (c) 2022 IETF Trust and the persons identified as the document authors. All rights reserved.

This document is subject to BCP 78 and the IETF Trust's Legal Provisions Relating to IETF Documents (<https://trustee.ietf.org/license-info>) in effect on the date of publication of this document. Please review these documents carefully, as they describe your rights and restrictions with respect to this document. Code Components extracted from this document must include Revised BSD License text as described in Section 4.e of the Trust Legal Provisions and are provided without warranty as described in the Revised BSD License.

Table of Contents

1. Introduction
 2. Requirements Language
 3. Terminology
 4. Multihoming Scenarios
 - 4.1. Multihomed Residential: Single CPE
 - 4.2. Multihomed Enterprise: Single CPE, Multiple Upstream ISPs
 - 4.3. Multihomed Enterprise: Multiple CPEs, Multiple Upstream ISPs
 - 4.4. Multihomed Enterprise with the Same ISP
 5. DOTS Multihoming Deployment Considerations
 - 5.1. Residential CPE
 - 5.2. Multihomed Enterprise: Single CPE, Multiple Upstream ISPs
 - 5.3. Multihomed Enterprise: Multiple CPEs, Multiple Upstream ISPs
 - 5.4. Multihomed Enterprise: Single ISP
 6. Security Considerations
 7. IANA Considerations
 8. References
 - 8.1. Normative References
 - 8.2. Informative References
- Acknowledgements
- Authors' Addresses

1. Introduction

In many deployments, it may not be possible for a network to determine the cause of a DDoS attack [RFC4732]. Rather, the network may just realize that some resources appear to be under attack. To help with such situations, the IETF has specified the DDoS Open Threat Signaling (DOTS) architecture [RFC8811], where a DOTS client can inform an upstream DOTS server that its network is under a potential attack and that appropriate mitigation actions are required. The DOTS protocols can be used to coordinate real-time mitigation efforts that can evolve as the

attacks mutate, thereby reducing the impact of an attack and leading to more-efficient responsive actions. [RFC8903] identifies a set of scenarios for DOTS; most of these scenarios involve a Customer Premises Equipment (CPE).

The high-level base DOTS architecture is illustrated in Figure 1 (repeated from Section 2 of [RFC8811]):

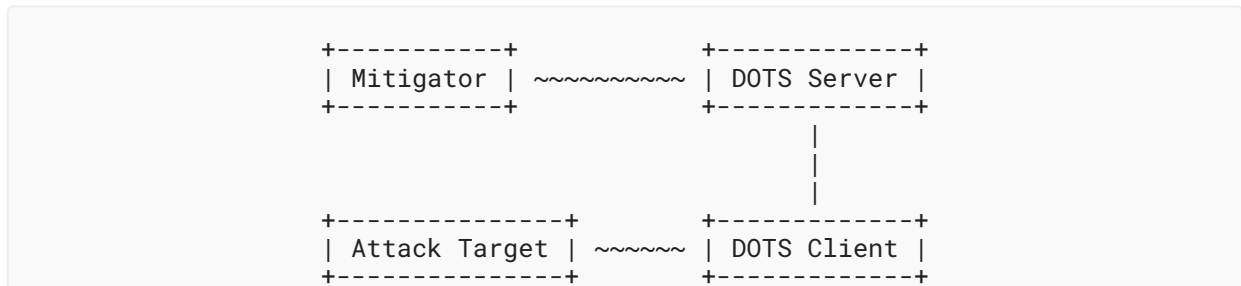

Figure 1: Basic DOTS Architecture

[RFC8811] specifies that the DOTS client may be provided with a list of DOTS servers; each of these servers is associated with one or more IP addresses. These addresses may or may not be of the same address family. The DOTS client establishes one or more DOTS sessions by connecting to the provided addresses for the DOTS server or servers [RFC8973].

DOTS may be deployed within networks that are connected to one single upstream provider. DOTS can also be enabled within networks that are multihomed. The reader may refer to [RFC3582] for an overview of multihoming goals and motivations. This document discusses DOTS multihoming considerations. Specifically, the document aims to:

1. Complete the base DOTS architecture with multihoming specifics. Those specifics need to be taken into account because:
 - Sending a DOTS mitigation request to an arbitrary DOTS server will not necessarily help in mitigating a DDoS attack.
 - Randomly replicating all DOTS mitigation requests among all available DOTS servers is suboptimal.
 - Sequentially contacting DOTS servers may increase the delay before a mitigation plan is enforced.
2. Identify DOTS deployment schemes in a multihoming context, where DOTS services can be offered by all or a subset of upstream providers.
3. Provide guidelines and recommendations for placing DOTS requests in multihomed networks, for example:
 - Select the appropriate DOTS server(s).
 - Identify cases where anycast is not recommended for DOTS.

This document adopts the following methodology:

- Identify and extract viable deployment candidates from [RFC8903].

- Augment the description with multihoming technicalities, for example:
 - One vs. multiple upstream network providers
 - One vs. multiple interconnect routers
 - Provider-Independent (PI) vs. Provider-Aggregatable (PA) IP addresses
- Describe the recommended behavior of DOTS clients and client-domain DOTS gateways for each case.

Multihomed DOTS agents are assumed to make use of the protocols defined in [RFC9132] and [RFC8783]. This document does not require any specific extension to the base DOTS protocols for deploying DOTS in a multihomed context.

2. Requirements Language

The key words "MUST", "MUST NOT", "REQUIRED", "SHALL", "SHALL NOT", "SHOULD", "SHOULD NOT", "RECOMMENDED", "NOT RECOMMENDED", "MAY", and "OPTIONAL" in this document are to be interpreted as described in BCP 14 [RFC2119] [RFC8174] when, and only when, they appear in all capitals, as shown here.

3. Terminology

This document makes use of the terms defined in [RFC8811], [RFC8612], and [RFC4116]. In particular:

Provider-Aggregatable (PA) addresses: globally unique addresses assigned by a transit provider to a customer. The addresses are considered "aggregatable" because the set of routes corresponding to the PA addresses are usually covered by an aggregate route set corresponding to the address space operated by the transit provider, from which the assignment was made (Section 2 of [RFC4116]).

Provider-Independent (PI) addresses: globally unique addresses that are not assigned by a transit provider, but are provided by some other organization, usually a Regional Internet Registry (RIR) (Section 2 of [RFC4116]).

IP indifferently refers to IPv4 or IPv6.

4. Multihoming Scenarios

This section describes some multihoming scenarios that are relevant to DOTS. In the following subsections, only the connections of border routers are shown; internal network topologies are not elaborated.

A multihomed network may enable DOTS for all or a subset of its upstream interconnection links. In such a case, DOTS servers can be explicitly configured or dynamically discovered by a DOTS client using means such as those discussed in [RFC8973]. These DOTS servers can be owned by the upstream provider, managed by a third-party (e.g., mitigation service provider), or a combination thereof.

If a DOTS server is explicitly configured, it is assumed that an interface is also provided to bind the DOTS service to an interconnection link. If no interface is provided, the DOTS server can be reached via any active interface.

This section distinguishes between residential CPEs and enterprise CPEs because PI addresses may be used for enterprises, which is not the current practice for residential CPEs.

In the following subsections, all or a subset of interconnection links are associated with DOTS servers.

4.1. Multihomed Residential: Single CPE

The scenario shown in Figure 2 is characterized as follows:

- The home network is connected to the Internet using one single CPE.
- The CPE is connected to multiple provisioning domains (i.e., both fixed and mobile networks). Provisioning Domain (PvD) is explained in [RFC7556].

In a typical deployment scenario, these provisioning domains are owned by the same provider (Section 1 of [RFC8803]). Such a deployment is meant to seamlessly use both fixed and cellular networks for bonding, faster handovers, or better resiliency purposes.

- Each of these provisioning domains assigns IP addresses or prefixes to the CPE and provides additional configuration information such as a list of DNS servers, DNS suffixes associated with the network, the default gateway address, and the DOTS server's name [RFC8973]. These addresses or prefixes are assumed to be Provider-Aggregatable (PA).
- Because of ingress filtering, packets forwarded by the CPE towards a given provisioning domain must be sent with a source IP address that was assigned by that domain [RFC8043].

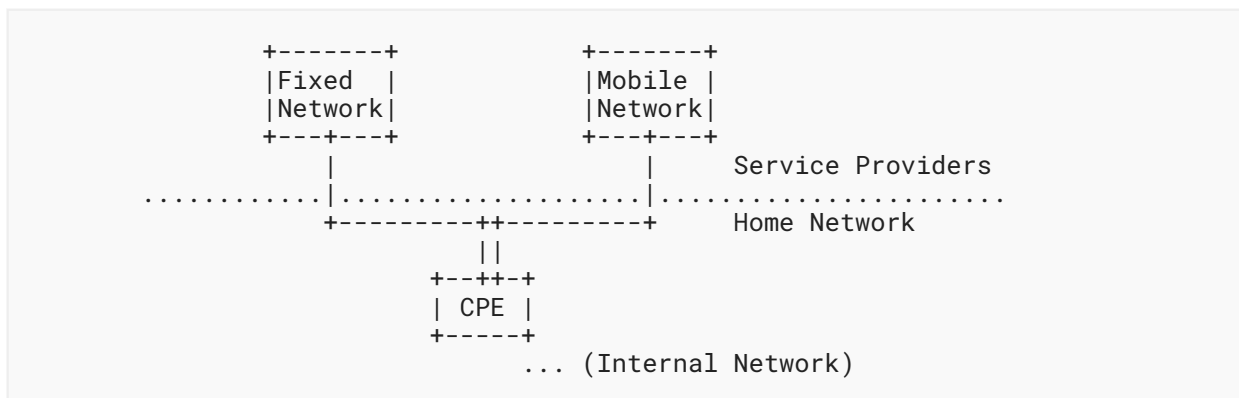

Figure 2: Typical Multihomed Residential CPE

4.2. Multihomed Enterprise: Single CPE, Multiple Upstream ISPs

The scenario shown in [Figure 3](#) is characterized as follows:

- The enterprise network is connected to the Internet using a single router.
- That router is connected to multiple provisioning domains managed by distinct administrative entities.

Unlike the previous scenario, two sub-cases can be considered for an enterprise network with regard to assigned addresses:

1. PI addresses or prefixes: The enterprise is the owner of the IP addresses or prefixes; the same address or prefix is then used when establishing communications over any of the provisioning domains.
2. PA addresses or prefixes: Each of the provisioning domains assigns IP addresses or prefixes to the enterprise network. These addresses or prefixes are used when communicating over the provisioning domain that assigned them.

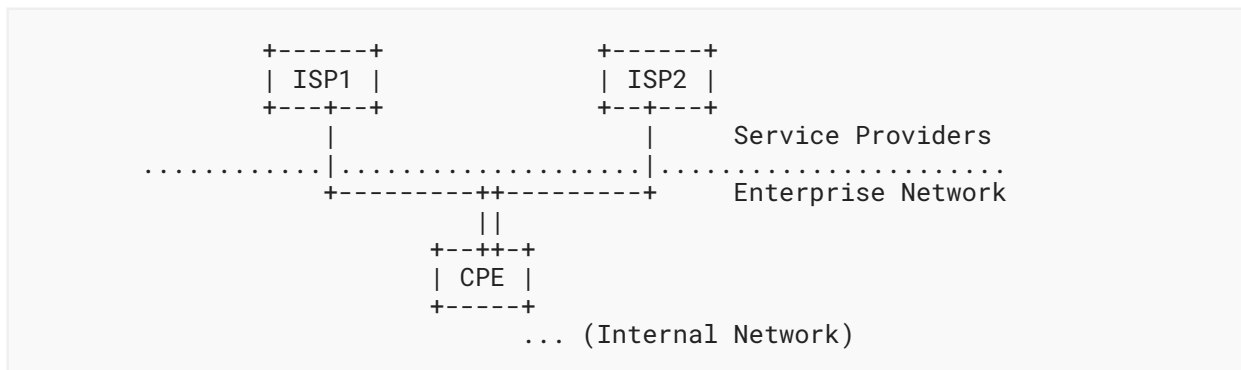

Figure 3: Multihomed Enterprise Network (Single CPE Connected to Multiple Networks)

4.3. Multihomed Enterprise: Multiple CPEs, Multiple Upstream ISPs

This scenario is similar to the one described in [Section 4.2](#); the main difference is that dedicated routers (CPE1 and CPE2) are used to connect to each provisioning domain.

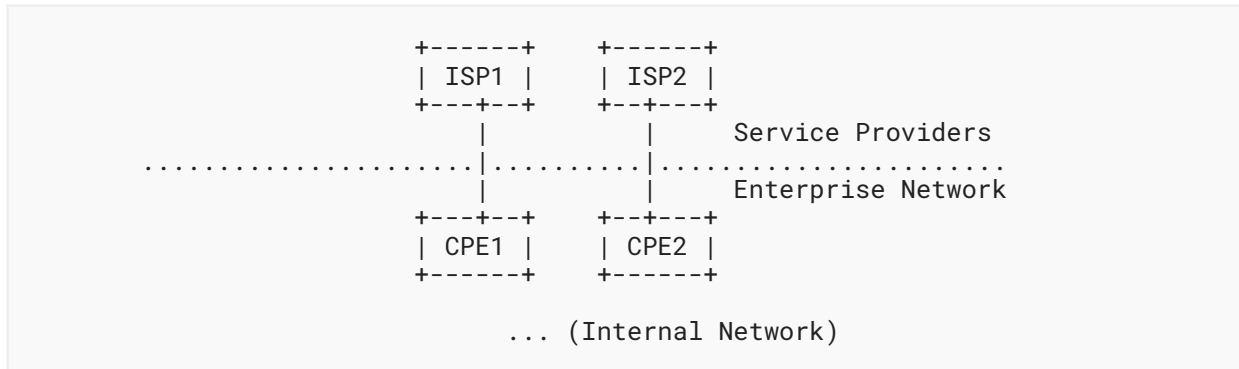

Figure 4: Multihomed Enterprise Network (Multiple CPEs, Multiple ISPs)

4.4. Multihomed Enterprise with the Same ISP

This scenario is a variant of Sections 4.2 and 4.3 in which multihoming is supported by the same ISP (i.e., same provisioning domain).

5. DOTS Multihoming Deployment Considerations

Table 1 provides some sample, non-exhaustive deployment schemes to illustrate how DOTS agents may be deployed for each of the scenarios introduced in Section 4.

Scenario	DOTS Client	Client-Domain DOTS Gateway
Residential CPE	CPE	N/A
Single CPE, multiple provisioning domains	Internal hosts or CPE	CPE
Multiple CPEs, multiple provisioning domains	Internal hosts or all CPEs (CPE1 and CPE2)	CPEs (CPE1 and CPE2)
Multihomed enterprise, single provisioning domain	Internal hosts or all CPEs (CPE1 and CPE2)	CPEs (CPE1 and CPE2)

Table 1: Sample Deployment Cases

These deployment schemes are further discussed in the following subsections.

5.1. Residential CPE

Figure 5 depicts DOTS sessions that need to be established between a DOTS client (C) and two DOTS servers (S1, S2) within the context of the scenario described in Section 4.1. As listed in Table 1, the DOTS client is hosted by the residential CPE.

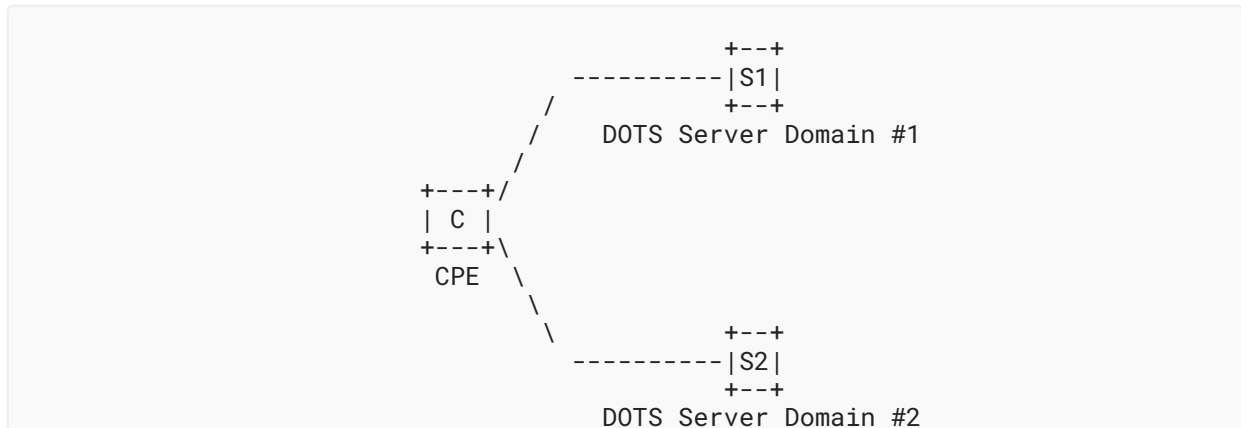

Figure 5: DOTS Associations for a Multihomed Residential CPE

The DOTS client **MUST** resolve the DOTS server's name provided by each provisioning domain using the DNS servers either learned from the respective provisioning domain or associated with the interface(s) for which a DOTS server was explicitly configured (Section 4). IPv6-capable DOTS clients **MUST** use the source address selection algorithm defined in [RFC6724] to select the candidate source addresses to contact each of these DOTS servers. DOTS sessions **MUST** be established and **MUST** be maintained with each of the DOTS servers because the mitigation scope of each of these servers is restricted. The DOTS client **MUST** use the security credentials (a certificate, typically) provided by a provisioning domain to authenticate itself to the DOTS server(s) provided by the same provisioning domain. How such security credentials are provided to the DOTS client is out of the scope of this document. The reader may refer to Section 7.1 of [RFC9132] for more details about DOTS authentication methods.

When conveying a mitigation request to protect the attack target(s), the DOTS client **MUST** select an available DOTS server whose network has assigned the IP prefixes from which target addresses or prefixes are derived. This implies that if no appropriate DOTS server is found, the DOTS client **MUST NOT** send the mitigation request to any other available DOTS server.

For example, a mitigation request to protect target resources bound to a PA IP address or prefix cannot be satisfied by a provisioning domain other than the one that owns those addresses or prefixes. Consequently, if a CPE detects a DDoS attack that spreads over all its network attachments, it **MUST** contact all DOTS servers for mitigation purposes.

The DOTS client **MUST** be able to associate a DOTS server with each provisioning domain it serves. For example, if the DOTS client is provisioned with S1 using DHCP when attaching to a first network and with S2 using Protocol Configuration Option (PCO) [TS.24008] when attaching to a second network, the DOTS client must record the interface from which a DOTS server was provisioned. A DOTS signaling session to a given DOTS server must be established using the interface from which the DOTS server was provisioned. If a DOTS server is explicitly configured, DOTS signaling with that server must be established via the interfaces that are indicated in the explicit configuration or via any active interface if no interface is configured.

5.2. Multihomed Enterprise: Single CPE, Multiple Upstream ISPs

Figure 6 illustrates the DOTS sessions that can be established with a client-domain DOTS gateway (hosted within the CPE as per Table 1) that is enabled within the context of the scenario described in Section 4.2. This deployment is characterized as follows:

- One or more DOTS clients are enabled in hosts located in the internal network.
- A client-domain DOTS gateway is enabled to aggregate and then relay the requests towards upstream DOTS servers.

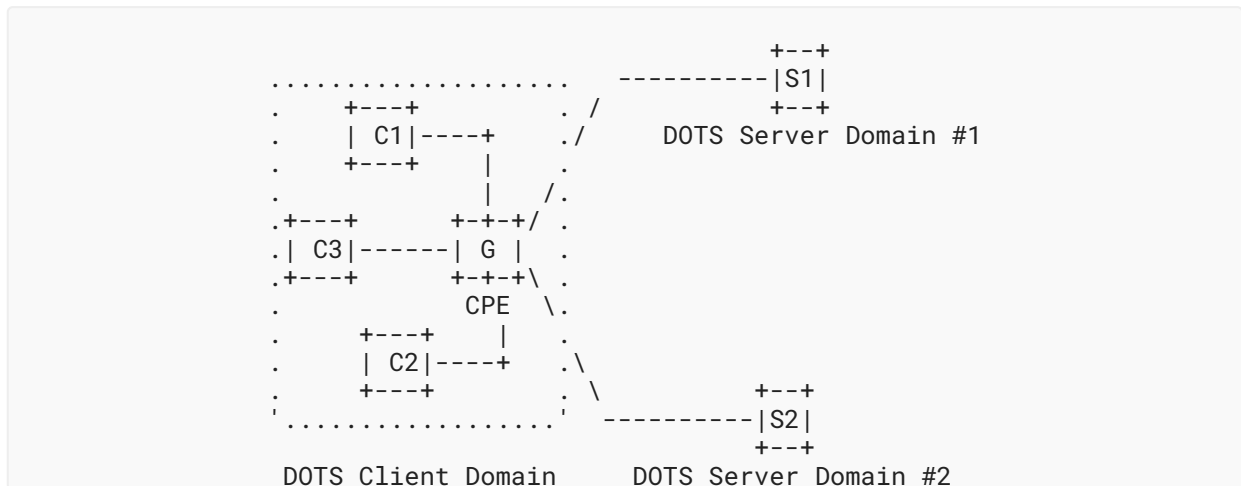

Figure 6: Multiple DOTS Clients, Single DOTS Gateway, Multiple DOTS Servers

When PA addresses or prefixes are in use, the same considerations discussed in Section 5.1 need to be followed by the client-domain DOTS gateway to contact its DOTS server(s). The client-domain DOTS gateways can be reachable from DOTS clients by using a unicast address or an anycast address (Section 3.2.4 of [RFC8811]).

Nevertheless, when PI addresses or prefixes are assigned, and absent any policy, the client-domain DOTS gateway **SHOULD** send mitigation requests to all its DOTS servers. Otherwise, the attack traffic may still be delivered via the ISP that hasn't received the mitigation request.

An alternate deployment model is depicted in Figure 7. This deployment assumes that:

- One or more DOTS clients are enabled in hosts located in the internal network. These DOTS clients may use [RFC8973] to discover their DOTS server(s).
- These DOTS clients communicate directly with upstream DOTS servers.

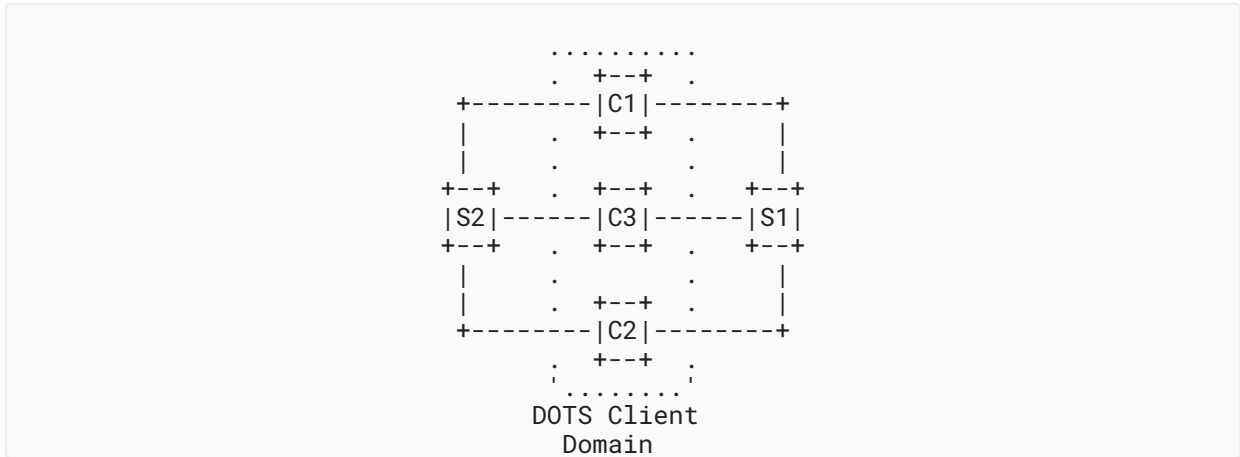

Figure 7: Multiple DOTS Clients, Multiple DOTS Servers

If PI addresses or prefixes are in use, the DOTS client **MUST** send a mitigation request to all the DOTS servers. The use of the same anycast addresses to reach these DOTS servers is **NOT RECOMMENDED**. If a well-known anycast address is used to reach multiple DOTS servers, the CPE may not be able to select the appropriate provisioning domain to which the mitigation request should be forwarded. As a consequence, the request may not be forwarded to the appropriate DOTS server.

If PA addresses or prefixes are used, the same considerations discussed in [Section 5.1](#) need to be followed by the DOTS clients. Because DOTS clients are not embedded in the CPE and multiple addresses or prefixes may not be assigned to the DOTS client (typically in an IPv4 context), some issues may arise in how to steer traffic towards the appropriate DOTS server by using the appropriate source IP address. These complications discussed in [\[RFC4116\]](#) are not specific to DOTS.

Another deployment approach is to enable many DOTS clients; each of them is responsible for handling communications with a specific DOTS server (see [Figure 8](#)).

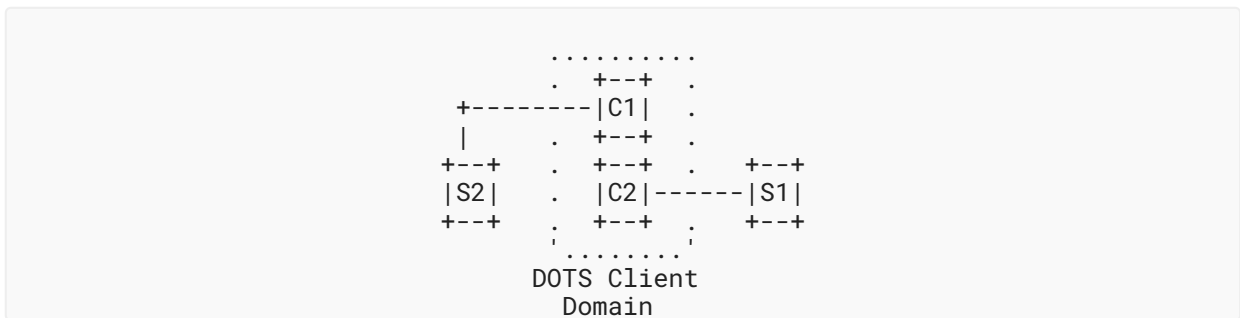

Figure 8: Single-Homed DOTS Clients

For both deployments depicted in Figures 7 and 8, each DOTS client **SHOULD** be provided with policies (e.g., a prefix filter that is used to filter DDoS detection alarms) that will trigger DOTS communications with the DOTS servers. Such policies will help the DOTS client to select the appropriate destination DOTS server. The CPE **MUST** select the appropriate source IP address when forwarding DOTS messages received from an internal DOTS client.

5.3. Multihomed Enterprise: Multiple CPEs, Multiple Upstream ISPs

The deployments depicted in Figures 7 and 8 also apply to the scenario described in Section 4.3. One specific problem for this scenario is to select the appropriate exit router when contacting a given DOTS server.

An alternative deployment scheme is shown in Figure 9:

- DOTS clients are enabled in hosts located in the internal network.
- A client-domain DOTS gateway is enabled in each CPE (CPE1 and CPE2 per Table 1).
- Each of these client-domain DOTS gateways communicates with the DOTS server of the provisioning domain.

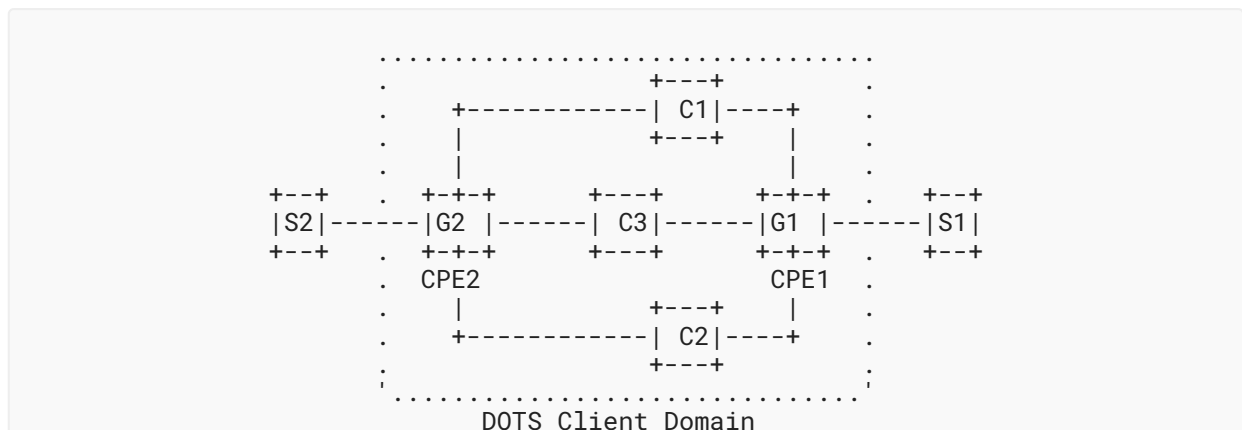

Figure 9: Multiple DOTS Clients, Multiple DOTS Gateways, Multiple DOTS Servers

When PI addresses or prefixes are used, DOTS clients **MUST** contact all the client-domain DOTS gateways to send a DOTS message. Client-domain DOTS gateways will then relay the request to the DOTS servers as a function of local policy. Note that (same) anycast addresses cannot be used to establish DOTS sessions between DOTS clients and client-domain DOTS gateways because only one DOTS gateway will receive the mitigation request.

When PA addresses/prefixes are used, but no filter rules are provided to DOTS clients, the DOTS clients **MUST** contact all client-domain DOTS gateways simultaneously to send a DOTS message. Client-domain DOTS gateways **MUST** check whether a received request is to be forwarded upstream (if the target IP prefix is managed by the upstream server) or rejected.

When PA addresses or prefixes are used, but specific filter rules are provided to DOTS clients using some means that are out of scope of this document, the clients **MUST** select the appropriate client-domain DOTS gateway to reach. The use of the same anycast addresses is **NOT RECOMMENDED** to reach client-domain DOTS gateways.

5.4. Multihomed Enterprise: Single ISP

The key difference between the scenario described in [Section 4.4](#) and the other scenarios is that multihoming is provided by the same ISP. Concretely, that ISP can decide to provision the enterprise network with:

- The same DOTS server for all network attachments.
- Distinct DOTS servers for each network attachment. These DOTS servers need to coordinate when a mitigation action is received from the enterprise network.

In both cases, DOTS agents enabled within the enterprise network **MAY** decide to select one or all network attachments to send DOTS mitigation requests.

6. Security Considerations

A set of security threats related to multihoming is discussed in [\[RFC4218\]](#).

DOTS-related security considerations are discussed in [Section 5](#) of [\[RFC8811\]](#).

DOTS clients should control the information that they share with peer DOTS servers. In particular, if a DOTS client maintains DOTS sessions with specific DOTS servers per interconnection link, the DOTS client **SHOULD NOT** leak information specific to a given link to DOTS servers on different interconnection links that are not authorized to mitigate attacks for that given link. Whether this constraint is relaxed is deployment specific and must be subject to explicit consent from the DOTS client domain administrator. How to seek such consent is implementation and deployment specific.

7. IANA Considerations

This document has no IANA actions.

8. References

8.1. Normative References

- [\[RFC2119\]](#) Bradner, S., "Key words for use in RFCs to Indicate Requirement Levels", BCP 14, RFC 2119, DOI 10.17487/RFC2119, March 1997, <<https://www.rfc-editor.org/info/rfc2119>>.

- [RFC6724] Thaler, D., Ed., Draves, R., Matsumoto, A., and T. Chown, "Default Address Selection for Internet Protocol Version 6 (IPv6)", RFC 6724, DOI 10.17487/RFC6724, September 2012, <<https://www.rfc-editor.org/info/rfc6724>>.
- [RFC8174] Leiba, B., "Ambiguity of Uppercase vs Lowercase in RFC 2119 Key Words", BCP 14, RFC 8174, DOI 10.17487/RFC8174, May 2017, <<https://www.rfc-editor.org/info/rfc8174>>.
- [RFC8811] Mortensen, A., Ed., Reddy, K. T., Ed., Andreasen, F., Teague, N., and R. Compton, "DDoS Open Threat Signaling (DOTS) Architecture", RFC 8811, DOI 10.17487/RFC8811, August 2020, <<https://www.rfc-editor.org/info/rfc8811>>.

8.2. Informative References

- [RFC3582] Abley, J., Black, B., and V. Gill, "Goals for IPv6 Site-Multihoming Architectures", RFC 3582, DOI 10.17487/RFC3582, August 2003, <<https://www.rfc-editor.org/info/rfc3582>>.
- [RFC4116] Abley, J., Lindqvist, K., Davies, E., Black, B., and V. Gill, "IPv4 Multihoming Practices and Limitations", RFC 4116, DOI 10.17487/RFC4116, July 2005, <<https://www.rfc-editor.org/info/rfc4116>>.
- [RFC4218] Nordmark, E. and T. Li, "Threats Relating to IPv6 Multihoming Solutions", RFC 4218, DOI 10.17487/RFC4218, October 2005, <<https://www.rfc-editor.org/info/rfc4218>>.
- [RFC4732] Handley, M., Ed., Rescorla, E., Ed., and IAB, "Internet Denial-of-Service Considerations", RFC 4732, DOI 10.17487/RFC4732, December 2006, <<https://www.rfc-editor.org/info/rfc4732>>.
- [RFC7556] Anipko, D., Ed., "Multiple Provisioning Domain Architecture", RFC 7556, DOI 10.17487/RFC7556, June 2015, <<https://www.rfc-editor.org/info/rfc7556>>.
- [RFC8043] Sarikaya, B. and M. Boucadair, "Source-Address-Dependent Routing and Source Address Selection for IPv6 Hosts: Overview of the Problem Space", RFC 8043, DOI 10.17487/RFC8043, January 2017, <<https://www.rfc-editor.org/info/rfc8043>>.
- [RFC8612] Mortensen, A., Reddy, T., and R. Moskowitz, "DDoS Open Threat Signaling (DOTS) Requirements", RFC 8612, DOI 10.17487/RFC8612, May 2019, <<https://www.rfc-editor.org/info/rfc8612>>.
- [RFC8783] Boucadair, M., Ed. and T. Reddy, K., Ed., "Distributed Denial-of-Service Open Threat Signaling (DOTS) Data Channel Specification", RFC 8783, DOI 10.17487/RFC8783, May 2020, <<https://www.rfc-editor.org/info/rfc8783>>.
- [RFC8803] Bonaventure, O., Ed., Boucadair, M., Ed., Gundavelli, S., Seo, S., and B. Hesmans, "0-RTT TCP Convert Protocol", RFC 8803, DOI 10.17487/RFC8803, July 2020, <<https://www.rfc-editor.org/info/rfc8803>>.

- [RFC8903]** Dobbins, R., Migault, D., Moskowitz, R., Teague, N., Xia, L., and K. Nishizuka, "Use Cases for DDoS Open Threat Signaling", RFC 8903, DOI 10.17487/RFC8903, May 2021, <<https://www.rfc-editor.org/info/rfc8903>>.
- [RFC8973]** Boucadair, M. and T. Reddy.K, "DDoS Open Threat Signaling (DOTS) Agent Discovery", RFC 8973, DOI 10.17487/RFC8973, January 2021, <<https://www.rfc-editor.org/info/rfc8973>>.
- [RFC9132]** Boucadair, M., Ed., Shallow, J., and T. Reddy.K, "Distributed Denial-of-Service Open Threat Signaling (DOTS) Signal Channel Specification", RFC 9132, DOI 10.17487/RFC9132, September 2021, <<https://www.rfc-editor.org/info/rfc9132>>.
- [TS.24008]** 3GPP, "Mobile radio interface Layer 3 specification; Core network protocols; Stage 3", 3GPP TS 24.008 16.3.0, December 2019, <<https://www.3gpp.org/DynaReport/24008.htm>>.

Acknowledgements

Thanks to Roland Dobbins, Nik Teague, Jon Shallow, Dan Wing, and Christian Jacquenet for sharing their comments on the mailing list.

Thanks to Kirill Kasavchenko for the comments.

Thanks to Kathleen Moriarty for the secdir review, Joel Jaeggli for the opsdir review, Mirja Kühlewind for the tsart review, and Dave Thaler for the intdir review.

Many thanks to Roman Danyliw for the careful AD review.

Thanks to Lars Eggert, Robert Wilton, Paul Wouters, Erik Kline, and Éric Vyncke for the IESG review.

Authors' Addresses

Mohamed Boucadair

Orange
35000 Rennes
France
Email: mohamed.boucadair@orange.com

Tirumaleswar Reddy.K

Nokia
Email: kondtir@gmail.com

Wei Pan

Huawei Technologies
Email: william.panwei@huawei.com