

264 Hardware Specification

By Dave Haynie
Bil Herd

REVISIONS

ZONE	LTR	DESCRIPTION	DATE	APPROVED
	1	ADVANCED ENGINEERING RELEASE		
	2	PILOT PRODUCTION RELEASE	12/1/83	Wm 87K
	A	PRODUCTION RELEASE		

UNLESS OTHERWISE SPECIFIED TOLERANCES ON: DECIMALS .X .XX .XXX .4'S ± ± ± ±		DRAWN BY: SJC		DATE 12-1-83
		CHKD: ENGR: <i>Wm</i> APPR: <i>Wm</i>		5 DEC 83 5 DEC 83
MATERIAL: FINISH:		USED ON TED 264		NEXT ASSY
commodore HARDWARE SPECIFICATION TED 264				
SIZE A			RE A	
SCALE —			SHEET 1 OF	

- I. SCOPE
- II. RELATED DOCUMENTS AND STANDARDS
 1. SYSTEM OVERVIEW
 2. SYSTEM ARCHITECTURE
 3. SYSTEM SPECIFICATIONS
 - 3.1 TED SYSTEM DIAGRAM
 - 3.2 MEMORY MAP
 - 3.3 POWER CONSUMPTION
 - 3.4 BUS LOADING
 - 3.5 CONFIGURATION
 - 3.6 ENVIRONMENTAL SPECIFICATION
 - 3.7 TIMING CHART
 - 3.8 TIMING DIAGRAM
 4. THE 7360 TEXT DISPLAY CHIP
 - 4.1 OVERVIEW
 - 4.2 FEATURES
 - 4.3 CHIP CHARACTERISTICS
 - 4.3.1 PINOUT
 - 4.3.2 SIGNAL DESCRIPTION
 - 4.4 ELECTRICAL SPECIFICATIONS
 - 4.4.1 ABSOLUTE MAXIMUM RATINGS
 - 4.4.2 VIDEO VOLTAGE SPECIFICATIONS
 - 4.4.3 LUMINANCE LEVELS
 - 4.4.4 COLOR PHASE ANGLES
 - 4.5 GENERAL TIMING
 - 4.5.1 BUS TIMING
 - 4.5.2 DMA TIMING
 - 4.5.2.1 TED DMA TIMING
 - 4.5.2.2 TED DMA TIMING DIAGRAM
 - 4.5.3 VIDEO TIMING
 - 4.5.3.1 HORZ TIMING
 - 4.5.3.2 VERT TIMING
 - 4.5.3.3 VIDEO TIMING DIAGRAM
 5. THE 7501 MICROPROCESSOR
 - 5.1 DESCRIPTION
 - 5.2 PINOUT
 - 5.3 ELECTRICAL SPECIFICATIONS
 - 5.3.1 MAXIMUM RATINGS
 - 5.3.2 ELECTRICAL CHARACTERISTICS
 - 5.4 SIGNAL DESCRIPTION
 - 5.5 PROCESSOR TIMING
 - 5.5.1 TIMING CHART
 - 5.5.2 TIMING DIAGRAM
 6. DYNAMIC RAMS
 - 6.1 ELECTRICAL SPECIFICATIONS
 - 6.2 CHARACTERISTICS
 - 6.2.1 PACKAGE PINOUT
 - 6.2.2 SELECTION CRITERIA
 - 6.3 TIMING
 - 6.3.1 TIMING CHART
 - 6.3.2 TIMING DIAGRAM

- 7. THE USER PORT
 - 7.1 DESCRIPTION
 - 7.2 PHYSICAL PINOUT
 - 7.3 ELECTRICAL SPECIFICATIONS
 - 7.4 TIMING
 - 7.5 6551, 6529 TIMING
 - 7.6 PLA PROGRAM CHART
 - 7.7 PHI 2, CS CLOCKS

- 8. THE VIDEO SECTION
 - 8.1 VIDEO INTERFACE
 - 8.2 MODULATOR SPECIFICATIONS
 - 8.3 MONITOR OUTPUT
 - 8.4 VIDEO CONNECTOR PINOUT

- 9. THE SERIAL BUS
 - 9.1 SERIAL BUS SPECIFICATION
 - 9.2 SERIAL BUS CONNECTOR PINOUT

- 10. THE EXPANSION BUS
 - 10.1 EXPANSION BUS PINOUT
 - 10.2 EXPANSION BUS SIGNAL DESCRIPTION

- 11. READ ONLY MEMORY
 - 11.1 SYSTEM ROM DESCRIPTION
 - 11.2 BANKING OPERATION
 - 11.3 ROM ELECTRICAL SPECIFICATION
 - 11.4 ROM PINOUT
 - 11.5 ROM TIMING

- 12. THE KEYBOARD
 - 12.1 KEYBOARD CONNECTOR PINOUT
 - 12.2 KEYBOARD MATRIX
 - 12.3 KEYBOARD ELECTRICAL SPECIFICATION

- 13. THE CIRCUIT BOARD
 - 13.1 PHYSICAL DIMENSIONS
 - 13.2 PARTS PLACEMENT

This document contains information concerning the architecture, hardware description, timing analysis, peripheral specification and driving software description for the Commodore system based on the 7360 I.C. (hereafter referred to as the TED I.C.) and the TED system. This document does not attempt to fully describe software aspects of the TED system and information concerning this subject can be found in the appropriate documents listed in section II.

II. RELATED DOCUMENTS AND STANDARDS

7360 SPECIFICATION

7501 SPECIFICATION

MOS TECHNOLOGY DATA BOOK 1982

SYNERTECH DATA BOOK 1983

TEDE 64 KEYBOARD STANDARD

FCC CLASS B - PART 5 SUBPART H STANDARDS

FCC CLASS B - TV INTERFACE STANDARDS

NTSC BROADCAST STANDARDS

PAL BROADCAST STANDARDS

1. SYSTEM OVERVIEW

The TED system is based on the 7501 microprocessor, which is an HMOS version of the 6510, working in conjunction with the 7360 Ted video processor. System RAM consists of 64K bytes of dynamic RAM composed of eight 64k X 1 devices. System program is contained in two 16K X 8 ROMs, and in it's standard configuration, consists of Kernal and Basic version 3.5 . The current implementation of the architecture for the Ted system supports up to 128K X 8 of ROM banked in 16K sections. ROM can be completely banked out and RAM banked in for a true 64K of RAM (minus two 256 byte pages). This allows 60,671 bytes available for Basic. The ROM/RAM banking is controlled by the 7360 under software control.

Keyboard scanning is done by outputting the row data on the Data bus while addressing a particular register in Ted, which will in turn cause Ted to latch the column information. Joystick scanning is done in the same manner.

Peripherals consist of standard serial bus products, (1541 disk drive, serial printer, ect.) cassette, TTL Serial ASCII which is intended to drive an RS-232 adapter. The expansion port supports ROM cartridges and a parallel disk drive interface.

SUMMARY OF TED SYSTEM FEATURES

- 7501 (6502 compatible) 8 bit CPU
- 7360 VLSI video, voice, DRAM controller
- 64KByte RAM
- 32KByte ROM for use in Kernal and Basic
- 32KByte ROM for Function Key software
- 32KByte ROM for Cartridge software
- Version 3.5 Basic with advanced graphics and DOS
(compatible with C64)
- 40 X 25 display with 128 colors
- 320 X 200 graphics resolution
- 2 Voices and white noise
- 64 keys including function keys
- Screen Editor with virtual windows
- Dual speed system clock for increased processing throughput
- External power supply (same as c64)
- Low chip count, high system integration

The Ted system employs a shared bus concept which allows the video processor and the microprocessor to access the same memory and I/O devices on alternate halves of the system clock. Bus access control is generated by the 7360. To increase microprocessor throughput, when this interleaving is not needed, the system clock doubles in frequency and the microprocessor is allowed full time on the bus. This occurs when no video information is being fetched by the 7360 (horizontal or vertical retrace, blank screen). There is an exception to this, and that is when the 7360 DMA's the 7501 micro to accomplish attribute fetch and character pointer information.

Dynamic RAM control signals are generated by the 7360. /RAS is generated once each memory cycle, while /CAS is generated depending on whether the memory cycle is a DRAM memory cycle or not. MUX is generated to control the multiplex of the Row and Column addresses going to the DRAMs. MUX also controls the holdoff of the R/W line as generated by the 7501. The R/W line is latched by the 7501 until the MUX line goes high signifying the end of the memory cycle. Refresh is provided by the 7360, refreshing 5 row locations (RAS only refresh) every raster line.

Selection of either ROM or RAM is accomplished by writing a bit in a Ted register. When RAM is selected, the whole 64K memory map is comprised of RAM with the exception of 2 registers for 7501 port, 1 page for Ted control registers, and 1 page for I/O. This method yields 60,671 bytes of RAM available for Basic program storage. When ROM is selected, the program residing in ROM appears in place of RAM. The exception to this is a write operation to ROM will always "bleed through" to underlying RAM.

Kernal and Basic can also be selectively swapped out and replaced with other 16 K sections of ROM. 2 sockets are provided internally for application programs (referred to as function key software) and address space is allocated for 2 ROMs external to the system (cartridge use, ect.). Swapping is taken care of by a Kernal routine that does not swap out, (located at \$FC00).

The cassette port and the Commodore serial bus port are implemented using the zero page ports available on the 7501 and using software control of hardware handshake.

The serial bus works with Commodore serial components, except for older peripherals that have a handshake timing problem.

The User Port is intended for external RS-232 adapters, and modem adapters. Transmission and reception is accomplished using a 6551 ACIA with handshaking assistance from a 6529 single port I.C.

The Joystick ports are functionally compatible with the standard Commodore 5 switch type Joystick. They are not compatible with analog type peripherals such as paddles, tablets, etc., as well as not being pin compatible.

The video connector has composite video as well as separate chroma and luminance outputs for use with monitors. The 1701, 1702 type Commodore monitors interface directly to this connector.

The RF output Jack supplies an RF signal compatible with the regulations pertaining to TV interface devices, and is switch selectable between channels 3 and 4. Both NTSC and PAL television standards are supported.

3. SYSTEM SPECIFICATIONS

This section covers the range of system operation by discussing various constraints and features of the TED system as a whole. Included are descriptions of the system as configured and limiting factors of power, loading, and environment.

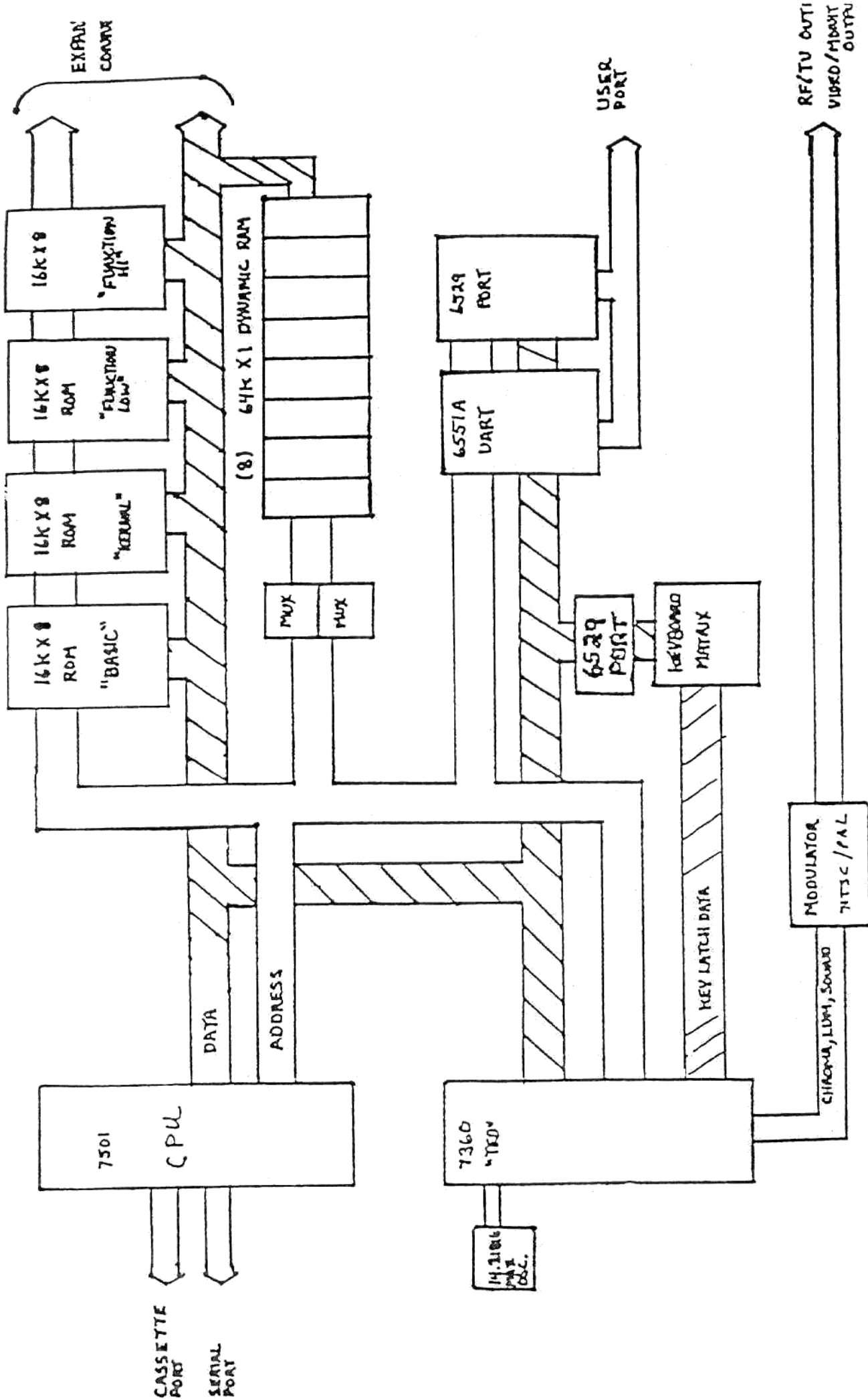

3.1 TED 64 SYSTEM DIAGRAM

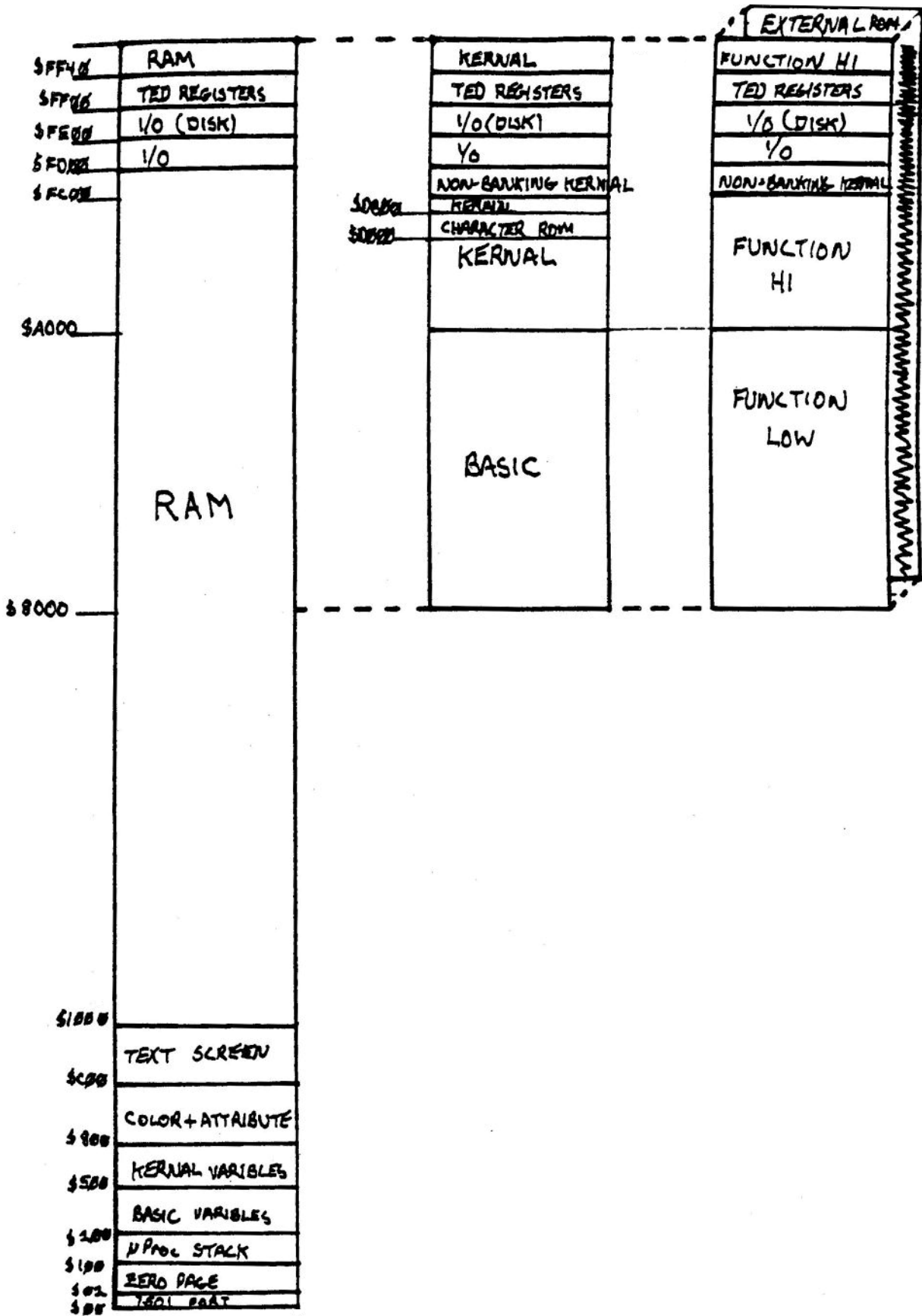

3.2 TED MEMORY MAP 64K

3.3 POWER CONSUMPTION

PART	I TOTAL (TYP)	I TOTAL (MAX)	ma	
7501	80	125	ma	
7360	200	250	ma	
23128	155	220	ma	KERNAL, BASIC
74LS257	24	38	ma	
modulator	80	150	ma	
555	10	15	ma	
7406	32	51	ma	
74LS08	4	9	ma	
74LS04	4	7	ma	
7700-xx	85	120	ma	
4164-2	336	480	ma	
6551A	34	60	ma	
6529B	56	80	ma	
	1156	1685	ma	W/O FUNCTION KEY SOFTWARE
23128	155	220	ma	FUNCTION KEY ROM
	1311	1905	ma	TED W/FUNCTION SOFTWARE
23128	155	220	ma	CARTRIDGE ROM
	1466	2125	ma	TED64 FUNCTION AND CART
RS - 232	1536	2225	ma	TED64 FUNC. W/CART & RS-232

** 1.53 A TYP. 2.2 A MAX. **

3.4 BUS LOADING

DEVICE	ADDRESS	DATA	R/W	RAS CAS	
7501	12	15	12	-	Pf
7360	10	10	10	10	Pf
4164	-	20	80	80	Pf
7700	8	-	-	8	Pf
6551	10	10	10	-	Pf
(2)6529	-	20	20	-	Pf
74LS257	5	-	-	-	Pf
(2)23128	16	16	-	-	Pf

	61	91	132	98	Pf *
	77	107	132	98	Pf **
	93	123	132	98	Pf ***

* TED64
 ** TED64 W/FUNCTION ROMS
 *** TED64 W/FUNCTION & CART

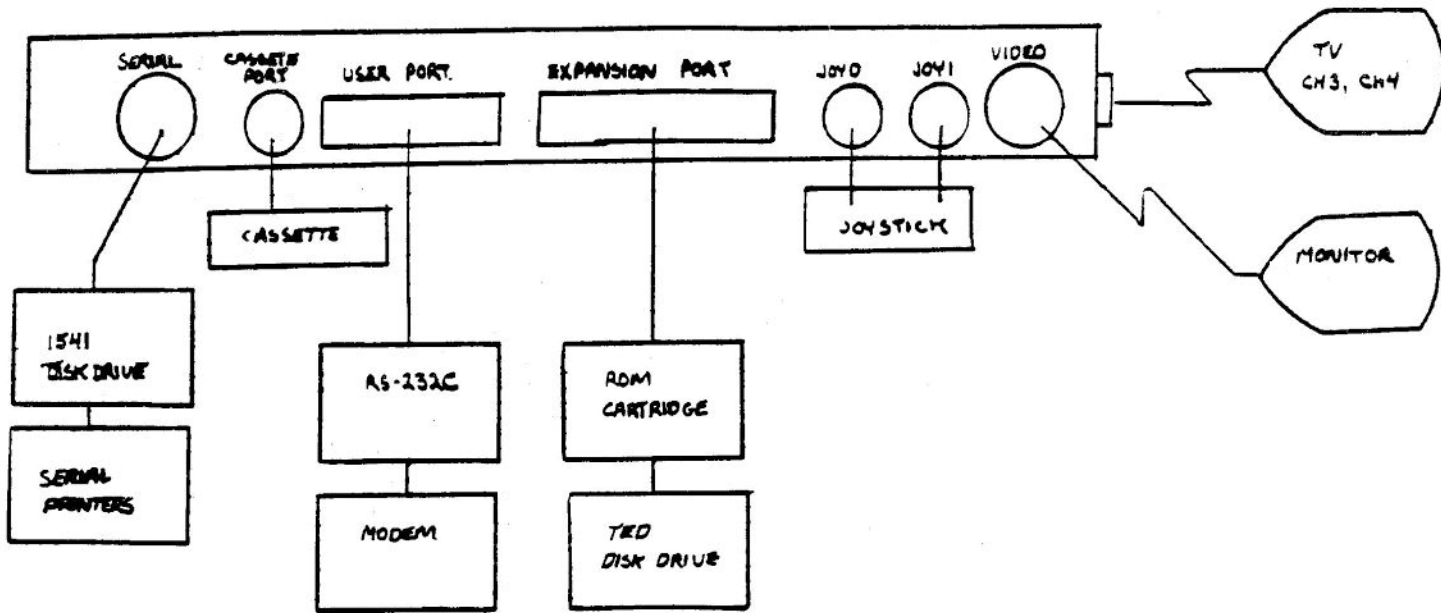

3.5 TED SYSTEM CONFIGURATION

The system is rated to operate over the range from 10 degrees Celsius to 50 degrees Celsius. Additionally, it will operate over a relative humidity range from 5% to 95% non-condensing.

This chapter will discuss various aspects of the 7360 Text Display chip.

4.1 OVERVIEW

The 7360 (or TED) is intended for low end 6502 family based, personal home computer systems. The 7360 is a 48 pin device which controls video output, (all signals necessary to create composite video), system timing, dynamic RAM control, ROM control, and keyboard scanning. The 7360 contains 34 control registers which are accessed through the standard 6502 microprocessor data bus. The 7360 uses the MOS technology HMOS process, and is upgradable to HMOS 2.

4.2 FEATURES

HARDWARE FEATURES:

DYNAMIC RAM REFRESH

SOUND GENERATION

PROGRAMMABLE VIDEO TIME STANDARDS
(compatible with either NTSC or PAL standards)

40 COLUMN X 25 ROW CHARACTER DISPLAY

8 X 8 CHARACTER DOT MATRIX

320 X 200 PIXEL RESOLUTION

16 UNIQUE COLORS, 8 LUMINENCE LEVELS

HARDWARE FLASH

HARDWARE CURSOR

HARDWARE REVERSE VIDEO

PROGRAMMABLE CHARACTER INFORMATION SOURCE
(ROM or RAM)

DUAL SPEED CLOCK

SCREEN BLANKING FOR DMA SENSITIVE ENVIROMENTS

4.3 CHIP CHARACTERISTICS

This section discusses some of the physical characteristics of the TED chip.

4.3.1 PINOUT

PIN	DESIGNATION	DESCRIPTION
1	A2	ADDRESS BIT 2
2	A1	ADDRESS BIT 1
3	A0	ADDRESS BIT 0
4	VCC	POWER SUPPLY +5
5	CS0	LOW ROM CHIP SELECT
6	CS1	HI ROM CHIP SELECT
7	R/W	READ/WRITE LINE
8	/IRQ	INTERUPT REQUEST
9	MUX	ADDRESS MULTIPLEX CONTROL
10	/RAS	DYNAMIC RAM ROW ADDRESS STROBE
11	/CAS	DYNAMIC RAM COLUMN ADDRESS STROBE
12	ODUT	SYSTEM CLOCK
13	COLOR	CHROMA OUTPUT
14	OIN	MASTER CLOCK
15	K0	KEYBOARD LATCH 0
16	K1	KEYBOARD LATCH 1
17	K2	KEYBOARD LATCH 2
18	K3	KEYBOARD LATCH 3
19	K4	KEYBOARD LATCH 4
20	K5	KEYBOARD LATCH 5
21	K6	KEYBOARD LATCH 6
22	K7	KEYBOARD LATCH 7
23	LUM	COMPOSITE SYNC AND LUMINENCE
24	VSS	POWER SUPPLY GROUND
25	DB0	DATA BIT 0
26	DB1	DATA BIT 1
27	DB2	DATA BIT 2
28	DB3	DATA BIT 3
29	DB4	DATA BIT 4
30	DB5	DATA BIT 5
31	DB6	DATA BIT 6
32	DB7	DATA BIT 7
33	SND	SOUND OUTPUT
34	BA	BUS AVAILABLE
35	AEC	ADDRESS ENABLE CONTROL
36	A15	ADDRESS BIT 15
37	A14	ADDRESS BIT 14
38	A13	ADDRESS BIT 13
39	A12	ADDRESS BIT 12
40	A11	ADDRESS BIT 11
41	A10	ADDRESS BIT 10
42	A9	ADDRESS BIT 9
43	A8	ADDRESS BIT 8
44	A7	ADDRESS BIT 7
45	A6	ADDRESS BIT 6
46	A5	ADDRESS BIT 5
47	A4	ADDRESS BIT 4
48	A3	ADDRESS BIT 3

4.3.2 SIGNAL DESCRIPTION

ADDRESS BUS Pins 1 thru 3 and 36 thru 48

The 16 bit address bus is bidirectional. As an input, the microprocessor can access any of the 34 TED control registers. In the output mode TED uses the addresses to fetch Video Matrix Pointers, Attribute Pointers or character cell information. For microprocessor interface TED resides in locations FF00-FF3F in memory.

DATA BUS Pins 25 thru 36

The 8 bit data bus is also bidirectional. The data bus activity can be separated into 2 categories: microprocessor interface and video data interface during the above mentioned fetches.

KEYBOARD LATCH Pins 15 thru 22

The 8 bit keyboard latch is used as the keyboard interface. Upon instruction by the microprocessor to write to the keyboard latch, the information on the keyboard pins is latched by TED and stored until it is retrieved by the microprocessor on a read keyboard instruction. The 7360 also provides active pull ups on the keyboard matrix lines.

K0 and K1 (2 of the keyboard lines) also provide testing functions. When these pins are externally driven to 10 volts, they provide specific testing features. It should be noted however, that these pins are high impedance and if subjected to high energy electromotive fields, could cause false generation of the testing functions. This can be protected against through use of diodes to insure the potential on K0 and K1 never exceeds VCC. K0 generates a system freeze function, and sets all horizontal flip-flops to force TED into the dynamic RAM refresh period and single clock. All flip-flops are then released to allow their manipulation by the horizontal register. K1 forces the internal clock division into the NTSC mode.

CHIP SELECTS Pins 5 and 6

TED generates ROM chip selects based on address decoding. CS0 is active during the memory block of 8000-BFFF (HEX). CS1 corresponds to C000-FFFF (HEX) in memory. The ROM area of memory can be banked out to overlay RAM, see the description of Registers 3E and 3F (HEX).

DYNAMIC RAM CONTROL Pins 9 thru 11

TED generates /RAS and /CAS for dynamic RAM access. The signal MUX is also generated to externally multiplex the RAM row and column addresses.

READ/WRITE Pin 7

R/W is an input to TED to distinguish the type of operation to be performed. TED will actively pull up the system read line during all TED fetches. The read signal is qualified with MUX. The pin is an open source output.

INTERRUPT Pin 8

The interrupt pin is an open drain output. TED contains four interrupt sources: 3 internal timers and the raster comparator.

PHI OUT Pin 12

For increased processor throughput, TED doubles the frequency of the system clock during horizontal and vertical blanking. The actual single clock boundaries are:

- 1) Raster lines 0-204 and horizontal positions 400-344
- 2) Horizontal positions 304-344

PHI IN Pin 14

For use in NTSC television systems, TED requires a 14.31818 MHz +/- 70 ppm single phase clock input. For PAL systems, the input clock must be 17.734475 MHz +/- 70 ppm single phase.

COMPOSITE COLOR Pin 13

The color output contains all chrominance information, including the color reference burst signal and the color of all display data. The color output is open source and should be terminated with 1K ohms to ground.

COMPOSITE SYNC AND LUMINANCE Pin 23

The luminance output contains all video synchronization as well as luminance information for the video display. The pin is open drain, requiring an external pullup of 1K Ohm.

SOUND Pin 33

This pin provides the output of the 2 tone generators. The output must be integrated through an RC network and then buffered to drive an external speaker.

BUS AVAILABLE Pin 34

Bus Available indicates the state of TED with respect to video memory fetches. BA will go low during phase 1, 3 single clock cycles before TED performs any memory access and will remain low for the entire fetch.

ADDRESS ENABLE CONTROL Pin 35

During double clock mode, AEC is always high allowing the 7501 complete control of the system buses. For single clock time periods, when BA has not gone low, AEC will toggle with PHI2 out. This allows TED PHI1, time to complete its memory accesses of video dot information while the 7501 performs during PHI2. When TED needs both halves of the cycle to perform its customary PHI1 dot fetches and PHI2 attribute and pointer fetches, BA will go low. On the fourth PHI1 out, AEC will remain low until the end of the PHI2 video fetch.

4.4 ELECTRICAL SPECIFICATIONS

This section discusses some of the electrical properties and considerations of the 7360 TED chip.

4.4.1 ABSOLUTE MAXIMUM RATINGS

INPUT VOLTAGE (V_{in})	-2V to +7.0 VDC
SUPPLY VOLTAGE (V_{cc})	-2V to +7.0 VDC
OPERATING TEMP (T_a)	0 to 70 °C
STORAGE TEMP	-55 to 150 °C
INPUT LEAKAGE CURRENT	-1.0 μ A
DYNAMIC CHARACTERISTICS	$V_{cc} = 5.0V \pm 5\%$
INPUT HIGH VOLTAGE (V_{IH})	$V_{ss}+2.4V$ to $V_{cc}+1V$
INPUT LOW VOLTAGE (V_{IL})	$V_{SS}-2V$ to $V_{ss}+.8V$
OUTPUT HIGH VOLTAGE (V_{OH})	$V_{SS}+2.4V$
($I_{OH}=-200\mu A$ $V_{CC}=4.75V_{DC}$)	
OUTPUT LOW VOLTAGE (V_{OL})	$V_{SS}+.4V$
($I_{OL}=-3.2ma$ $V_{CC}=5.25V$)	
MAX POWER SUPPLY CURRENT	250ma

4.4.2 VIDEO VOLTAGE SPECIFICATIONS

CHROMA OUT	1V _{P-P} min. w/2VOLT OFFSET OPEN SOURCE
LUM OUT	0-5V (blanking = .5V) OPEN DRAIN

4.4.3 LUMINANCE LEVELS (R7)

LEVEL	VOLTAGE	
00	2.00	V
01	2.4	V
02	2.55	V
03	2.7	V
04	2.9	V
05	3.3	V
06	3.6	V
07	4.1	V
08	4.8	V

4.4.4 COLOR PHASE ANGLES

COLOR	HUE PHASE (relative to SIN, in degrees)	
	NTSC	PAL
BLACK	--	--
WHITE	--	--
RED	70	103
CYAN	250	283
MAGENTA	20	53
GREEN	208	241
BLUE	314	347
YELLOW	134	167
ORANGE	90	129
BROWN	115	148
YLLW-GRN	162	195
PINK	50	83
BLU-GRN	232	265
LT-BLU	290	323
DK-BLU	350	23
LT-GRN	180	213

4.5 GENERAL TIMING

This section explores the various timing considerations and constraints related to the TED chip.

4.5.1 BUS TIMING

PARAMETER	SYMBOL	MIN	MAX	UNIT
TED ADDR SETUP	TADS	-	150	ns
INPUT DATA SETUP	TDSU	50	-	ns
INPUT DATA HOLD	TDH	10	-	ns
OUTPUT DATA STABLE	TDSO	160	-	ns
OUTPUT DATA HOLD	TDHO	80	120	ns
R/W STABLE PERIOD	TRWS	-	178	ns
MUX TO R/W SETUP	TMRWS	-	70	ns
MUX TO R/W HOLD	TMRWH	30	-	ns
CHIP SELECT SETUP	TCSS	-	320	ns
CHIP SELECT HOLD	TCSH	70	-	ns
ADDRESS HOLD	TAH	60	-	ns
ADDRESS IN TRISTATE	TADTH	-	135	ns

4.5.2 DMA TIMING

The 7360 performs DMA's to fetch additional information to maintain a video display. Twice per each row of characters, (a character being defined as a cell 8 X 8 bits) to obtain the attributes for each character and to obtain the character pointer which points to where the character pattern can be found. In bit map mode, these DMA's still occur, but the information is interpreted differently. The sequence of events in a DMA cycle are: 1)The system clock comes out of double speed for 1 cycle. At the same time AEC starts to toggle, allowing the 7360 on the bus. 2)The Bus Available line goes low. 3)Three cycles are given to the 7501 to complete operation before DMA begins. 4)40 cycles of single clock where the 7360 is doing 2 fetches per cycle. 5)BA goes high at the same time as AEC allowing the 7501 back on the bus. 6)5 cycles follow of single speed where the 7360 is engaged in refreshing the dynamic RAM. 7)16 cycles of double speed (equiv. to 8 cycles of single) 8) If last DMA was row 8 of character, then DMA for row 1 of next character is initiated. If screen is blanked, the 5 cycles of single speed are still present for dynamic RAM refresh.

4.5.2.1 TED DMA TIMING (REFER TO 4.5.2.2 TED DMA TIMING DIAGRAM)

	cycles	time	
TDMA	40	46us	TIME, DMA
THALT	3	3us	TIME, HALT
TRFSH	5	5us	TIME, REFRESH
TDS	16	9us	TIME, DOUBLE SPEED
TS	1	1us	TIME, SYNCHRONIZE

Diagram 4.5.2.2 represents the occurrence of when two DMAs are "back to back", I.E. character row 8 DMAs, then character row 1 of the next character DMAs, seperated only by one horizontal retrace.

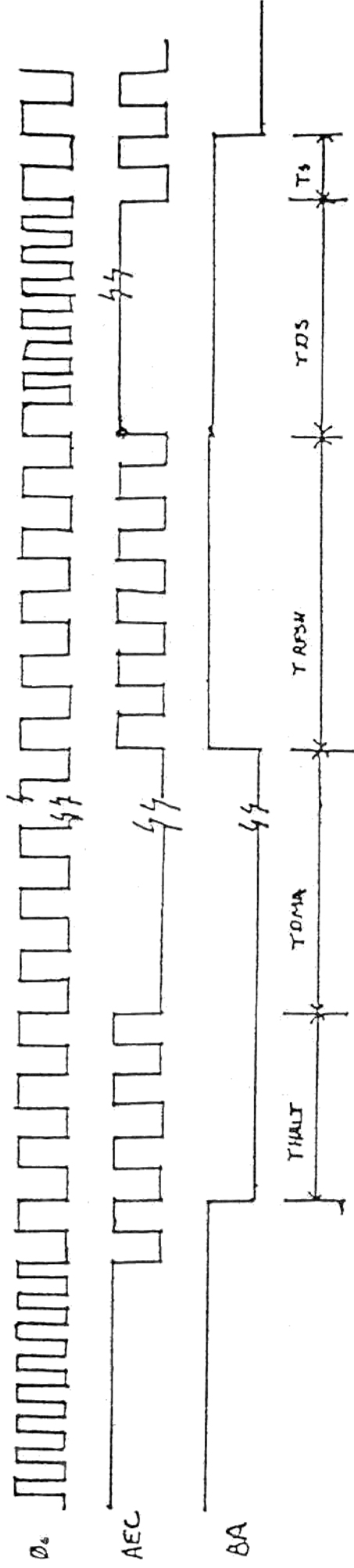

4.5.2.2 TED DMA TIMING DIAGRAM

4.5.3 VIDEO TIMING

This subsection discusses some of the properties of the TED video section timings.

4.5.3.1 HORIZONTAL TIMING

PERIOD	TIME	
	NTSC	PAL
TOTAL LINE	63.5 μ S	64 μ S
H BLANKING	9.5 - 11.5	μ S
H SYNC PULSE	4.75 +/- 0.5	μ S
FRONT PORCH	1.27 (MIN)	μ S
BACK PORCH	3.91 (MIN)	μ S
COLOR BURST	8-11 CYCLES	3.58MHZ +/- 250 HZ
VISIBLE LINE TIME	52-54	μ S

4.5.3.2 VERTICAL TIMING

PERIOD	TIME	
	NTSC	PAL
TOTAL FIELD	.0167	SEC
V BLANKING	.0008-.0013	SEC
V SYNC PULSE	31.75	μ S
6 V SYNC PULSES	190.5	μ S
EQ PULSE	2.54	μ S
SERATION PULSE	2.54	μ S
VISIBLE FIELD	.015-.016	SEC

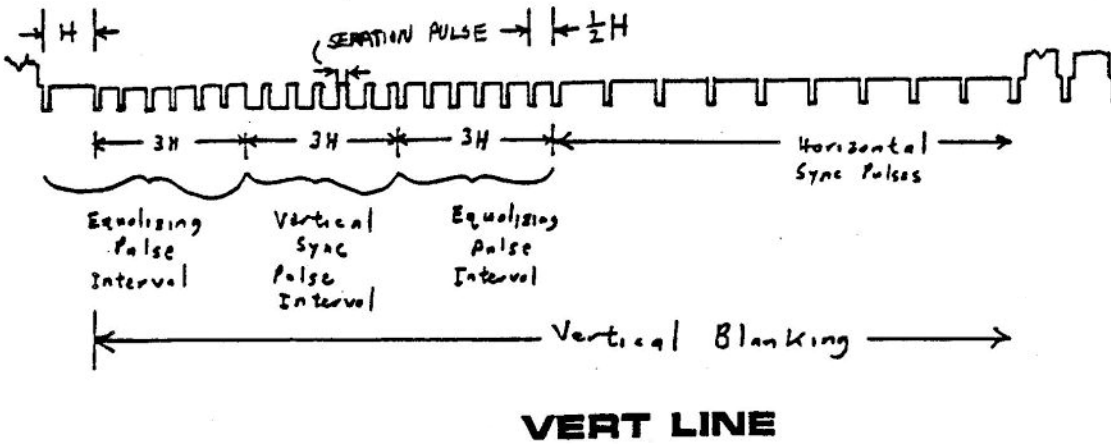
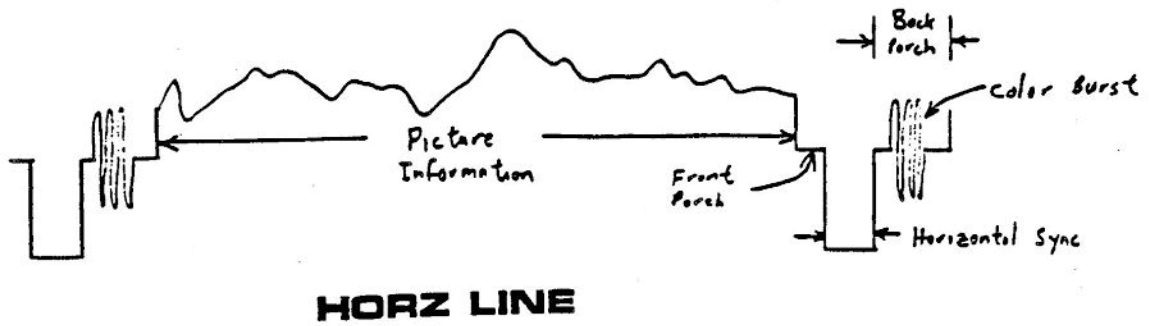

4.5.3.3 VIDEO TIMING DIAGRAM

This section describes some of the properties and functions of the type 7501 microprocessor.

5.1 7501 DESCRIPTION

The 7501 is an HMOS version of the 6502 family or more specifically, the 6510CBM. The 7501 is software compatible with existing 6502, 6510 code. The 7501 contains a 7 bit bi-directional port used to directly drive the serial bus and cassette. The port is at location \$0000 while the data direction register is at \$0001. The 7501 is Tri-statable and through use of the AEC (address enable control) line and is used extensively in the TED shared bus concept. DMA is accomplished using the AEC line and the RDY line (called BA on TED). A control line is provided (GATE IN) to hold off the R/W line until /RAS makes the transition from low to hi. This prevents the Read line from making an early transition to the write state which would cause an improper Early Write Cycle to occur.

PIN	NAME	DESCRIPTION
1	PHI IN	SYSTEM CLOCK INPUT
2	RDY	DMA RQST
3	/IRQ	INTERUPT RQST
4	AEC	ADDRESS ENABLE CONTROL
5	VCC	POWER SUPPLY +5V.
6	A0	ADDRESS BIT 0
7	A1	ADDRESS BIT 1
8	A2	ADDRESS BIT 2
9	A3	ADDRESS BIT 3
10	A4	ADDRESS BIT 4
11	A5	ADDRESS BIT 5
12	A6	ADDRESS BIT 6
13	A7	ADDRESS BIT 7
14	A8	ADDRESS BIT 8
15	A9	ADDRESS BIT 9
16	A10	ADDRESS BIT 10
17	A11	ADDRESS BIT 11
18	A12	ADDRESS BIT 12
19	A13	ADDRESS BIT 13
20	GND	POWER SUPPLY GROUND
21	A14	ADDRESS BIT 14
22	A15	ADDRESS BIT 15
23	GATE IN	R/W GATE
24	P7	PORT BIT 7
25	P6	PORT BIT 6
26	P4	PORT BIT 4
27	P3	PORT BIT 3
28	P2	PORT BIT 2
29	P1	PORT BIT 1
30	P0	PORT BIT 0
31	DB7	DATA BIT 7
32	DB6	DATA BIT 6
33	DB5	DATA BIT 5
34	DB4	DATA BIT 4
35	DB3	DATA BIT 3
36	DB2	DATA BIT 2
37	DB1	DATA BIT 1
38	DB0	DATA BIT 0
39	R/W	READ/WRITE
40	RES	RESET

5.3 7501 ELECTRICAL SPECIFICATIONS

This section describes some of the electrical constraints and specifications of the system.

5.3.1 MAXIMUM RATINGS

Rating	Symbol	Value	Unit
Supply Voltage	Vcc	-0.3 to +7.0	Vdc
Input Voltage	Vin	-0.3 to +7.0	Vdc
Operating Temperature	Ta	0 to +70	C
Storage Temperature	Tstg	-55 to +150	C

5.3.2 ELECTRICAL CHARACTERISTICS

Characteristic	Symbol	Min	Typ	Max	Unit
Input High Voltage Phi0(in) /RES,P0-P7,/IRQ,Data	V _{IH}	V _{SS} +2.4 V _{SS} +2.2	---	V _{CC} ---	V _{DC} V _{DC}
Input Low Voltage Phi0(in) /RES,P0-P7,/IRQ,Data	V _{IL}	V _{SS} -0.3 ---	---	V _{SS} +0.5 V _{SS} +0.8	V _{DC} V _{DC}
Input Leakage Current (V _{in} =0 to 5.25V, V _{CC} =5.25V) Logic Phi0(in)	I _{in}	---	---	2.5 10.0	uA uA
3-State(Off) Inp. Cur. (V _{in} =0.4 to 2.4V, V _{CC} =5.25V) Data Lines	I _{TSI}	---	---	10.0	uA
Output High Voltage (I _{OH} =-100uAdc, V _{CC} =4.75V) Data,A0-A15,R/W,P0-P7	V _{OH}	V _{SS} +2.4	---	---	V _{DC}
Output Low Voltage (I _{OL} =1.6mAdc, V _{CC} =4.75V) Data,A0-A15,R/W,P0-P7	V _{OL}	---	---	V _{SS} +0.4	V _{DC}
Power Supply Current	I _{CC}	---	125	---	mA
Capacitance (V _{in} =0,T _a =25 C, f=1MHz)	C				
Logic,P0-P7	C _{in}	---	---	10	pF
Data	C _{out}	---	---	15	pF
A0-A7	C _{out}	---	---	12	pF
Phi1	C _{Phi1}	---	30	50	pF
Phi2	C _{Phi2}	---	50	80	pF

5.4 SIGNAL DESCRIPTION

- CLOCK (PHI 0) - This is the dual speed system clock and is a standard TTL level input.
- ADDRESS BUS (A0 - A15) - TTL output. Capable of driving 2 TTL loads at 130 pf.
- DATA BUS (D0 - D7) - Bi-directional bus for transferring data to and from the device and the peripherals. The outputs are tri-state buffers capable of driving 2 standard TTL loads and 130pf.
- RESET - This input is used to reset or start the uprocessor from a power down condition. During the time that this line is held low, writing to or from the uprocessor is inhibited. When a positive edge is detected on the input, the uprocessor will immediately begin the reset sequence. After a system initialization time of 6 cycles, the mask interrupt flag will be set and the processor will load the program counter from the contents of memory locations \$FFFC and \$FFFD. This is the start location for program control. After VCC reaches 4.75 volts in a power up routine, reset must be held low for at least 2 cycles. At this time the R/W line will become valid.
- INTERUPT REQUEST (IRQ) - TTL input, request that the processor initiate an interrupt sequence. The processor will complete execution of the current instruction before recognizing the request. At that time, the interrupt mask in the Status Code Register will be examined. If the interrupt mask is not set, the processor will begin an interrupt sequence. The Program Counter and the Processor status register will be stored on the stack and the interrupt disable flag is set so that no other interrupts can occur. The processor will then load the program counter from the memory locations \$FFFE and \$FFFF.
- ADDRESS ENABLE CONTROL (AEC) - The Address Bus is only valid when the AEC line is high. When low, the address bus is in a high impedance state. This allows easy DMA's for shared bus systems.
- I/O PORT (P0-P4,P6,P7) - Bidirectional port used for transferring data to and from the processor directly. The Data Output Register is located at location \$0001 and the Data Direction Register is located at location \$0000.
- R/W - TTL level output from processor to control the direction of data transfer between the processor and memory, peripherals, etc. This line is high for reading memory and low for writing. This line is latched by the Gate In line to synchronize between a DRAM memory cycle and the processor clock cycle. If AEC is low when Gate In makes a low to high transition, the R/W line will go to a high impedance until the next transition of the Gate In line and AEC is high prior to the transition.

GATE IN - TTL level input, used to gate the R/W line to prevent the R/W line from going low during a read cycle, before RAS and CAS go high (resulting in a Read/Write cycle). Normally connected to the MUX line in a system configuration to synchronize the DRAM memory cycle to the processor clock cycle.

RDY - Ready. TTL level input, used to DMA the 7501. The processor operates normally while RDY is high. When RDY makes a transition to the low state, the processor will finish the operation it is on, and any subsequent operation if it is a write cycle. On the next occurrence of read cycle the processor will halt, making it possible to tri-state the processor to gain complete access to the system bus.

5.5 PROCESSOR TIMING

This section explores the timing considerations of the 7501 processor unit.

5.5.1 TIMING CHART

Electrical Characteristics $V_{cc} = 5v \pm 5\%$, $V_{ss} = 0v$, $T_A = 0^{\circ}C$ to $70^{\circ}C$

Characteristic	Symbol	Min	Max	Units
MUX input high	TMH	60	110	ns
AEC setup time	TAEC	25	60	ns
MUX to RW setup or tri-state	TMRWS		70	ns
MUX to RW hold	TMRWH	30		ns
Up data setup from PH0	TMDS		130	ns
Up write data hold	THW	60		ns
Up data setup from Mux	TMXDS		120	ns
Data bus to tri-state from MUX	TMXDT	30		ns
Data bus to tri-state from AEC	TAEDT		120	ns
Read data stable	TDSU	40		ns
Read data hold	THR	40		ns
Address setup from PH0	TADS	40	150	ns
Address hold	THA	40		ns
Address setup from AEC	TAADS		75	ns
Address tri-state from AEC	TAEAT		120	ns
Port input setup	TPDSU	105		ns
Port input half	TPDH	65		ns
Port output data valid	TPDW		195	ns
Cycle time	TCYC	500		ns
PH0(in) pulse width @1.5v	PWHPH0	250	275	ns
PH0(in) rise time	TRPH0		10	ns
PH0(in) fall time	TFPH0		10	ns
RDY setup time	TRDY	80		ns

5.5.2 7501 TIMING DIAGRAM

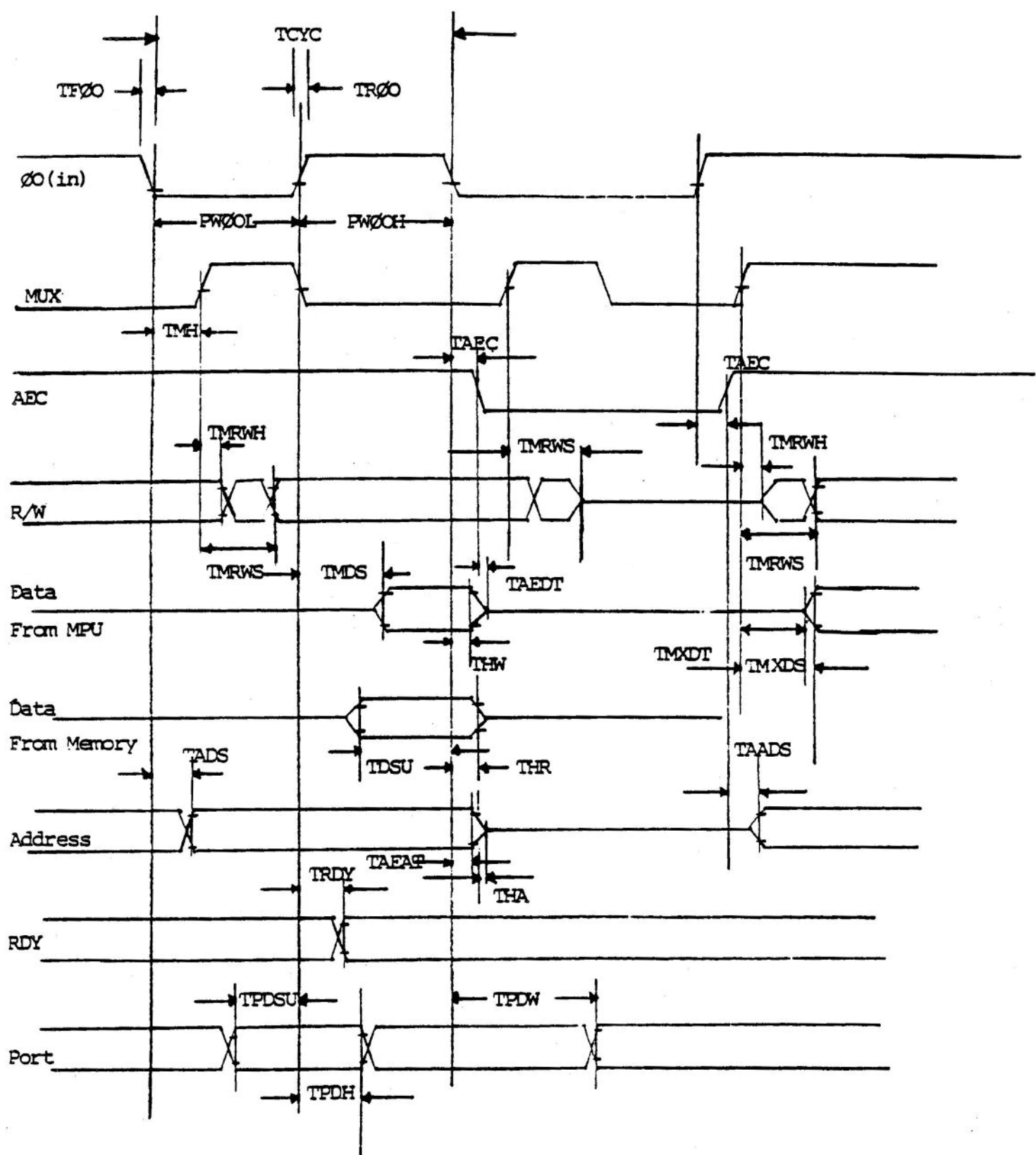

This chapter covers the constraints and features of dynamic random access memories used in the TED system.

6.1 ELECTRICAL SPECIFICATIONS

INPUT VOLTAGE (V_{in})	-1V to +7.0 VDC
SUPPLY VOLTAGE (V_{cc})	-1V to +7.0 VDC
OPERATING TEMP (T_a)	0 to 70 °C
STORAGE TEMP	-55 to 150 °C
INPUT LEAKAGE CURRENT	-10.0 μ A
DYNAMIC CHARACTERISTICS	$V_{cc} = 5.0V \pm 5\%$
INPUT HIGH VOLTAGE (V_{IH})	$V_{SS} + 2.4V$ to $V_{CC} + 1V$
INPUT LOW VOLTAGE (V_{IL})	$V_{SS} - 1V$ to $V_{SS} + 0.8V$
OUTPUT HIGH VOLTAGE (V_{OH}) ($I_{OH} = -200\mu A$ $V_{CC} = 4.75VDC$)	$V_{SS} + 2.4V$
OUTPUT LOW VOLTAGE (V_{OL}) ($I_{OL} = -4.2ma$ $V_{CC} = 5.25V$)	$V_{SS} + .4V$
MAX POWER SUPPLY CURRENT	80ma

6.2 CHARACTERISTICS

This section covers some of the characteristics of the 64K by 1 bit RAM that is used in the TED 64 system.

6.2.1 PACKAGE PINOUT

PIN	NAME	DESCRIPTION
1	NC	
2	Din	DATA IN
3	/WE	WRITE ENABLE (ACTIVE LOW)
4	/RAS	ROW ADDRESS STROBE (ACTIVE LOW)
5	A0	ADDRESS BIT 0
6	A2	ADDRESS BIT 2
7	A1	ADDRESS BIT 1
8	VCC	POWER SUPPLY +5
9	A7	ADDRESS BIT 7
10	A5	ADDRESS BIT 5
11	A4	ADDRESS BIT 4
12	A3	ADDRESS BIT 3
13	A6	ADDRESS BIT 6
14	Dout	DATA OUT
15	/CAS	COLUMN ADDRESS STROBE (ACTIVE LOW)
16	VSS	POWER SUPPLY GROUND

6.2.2 SELECTION CRITERIA

The TED system uses low cost 200 ns access RAMs. Qualified parts must meet all timing parameters as specified in section 6.3.1 "TIMING CHART" and 6.3.2 "TIMING DIAGRAM".

6.3 TIMING

This section illustrates the required timing constraints in dealing with DRAM.

7. THE USER PORT

This chapter details the system User Port.

7.1 DESCRIPTION

The USER PORT is included to allow various terminal and modem devices to connect to the TED system. Transmission and reception is via a 6551 ACIA, with handshaking assistance from a 6529 single port device. The 6551 and the 6529 are each accessible to the TED system in software, thus allowing their programming for various applications.

The 6551 ACIA is enabled by addresses \$FD00 to \$FD0F. The least significant two bits of the address will choose the mode, which may be set for transmit/receive, receive status, or programming of either the command register or the control register. Similarly, the 6529 is activated by the addresses \$FD10 to \$FD1F. It permits seven bits of either input or output, depending upon the status of the Read/Write line. The eighth bit, bit two to be exact, is used as the cassette sense input. It may be possible to utilize this bit if certain precautions are taken in software. (I.E. Insure that cassette sense is not grounded.)

The User Port itself provides access to various signals generated by these two chips, in addition to the ATN and Buffered Reset (BRESET) lines of the TED system. The port also provides ground, +5VDC and +9VAC for use by connected devices.

PIN	NAME	DESCRIPTION	DIRECTION
A	GND	Ground	-----
B	P0	I/O Port Bit 0	Input/Output
C	RxD	Recieve Data	Input
D	RTS	Request to Send	Output
E	DTR	Data Terminal Ready	Output
F	P7	I/O Port Bit 7	Input/Output
H	DCD	Data Carrier Detect	Input
J	P6	I/O Port Bit 6	Input/Output
K	CTS	Clear to Send	Input
L	DSR	Data Set Ready	Input
M	TxD	Transmit Data	Output
N	GND	Ground	-----
1	GND	Ground	-----
2	+5	+5 VDC	-----
3	/BRESET	Buffered System Reset	Output
4	P2/CST SENSE	I/O Port Bit 2	Input/Output
5	P3	I/O Port Bit 3	Input/Output
6	P4	I/O Port Bit 4	Input/Output
7	P5	I/O Port Bit 5	Input/Output
8	RxC	Recieve Clock	Input/Output
9	ATN	Attention	Output
10	+9	+9 VAC	-----
11	+9	+9 VAC	-----
12	GND	Ground	-----

7.3 ELECTRICAL SPECIFICATIONS

I/O Ports (P0,P2..P7)

These ports are capable of driving up to four TTL type loads each in output configuration.

Buffered Reset (/BRESET)

The buffered reset line is capable of driving at least one TTL level load. It can drive a total of ten TTL loads between the User Port, the Serial Port, and the Expansion Port.

Attention (ATN)

This line is capable of driving at least one TTL level load. It can drive a total of ten TTL loads between the User Port and the Serial Port.

Receive Data (RxD)

The Receive Data input may be driven by a single TTL level driver.

Other Inputs (DCD, DSR, CTS)

The remaining data inputs are buffered by TTL buffers. Each may be driven by a single TTL level driver. CTS is sensed via 6529 under software control.

Receive Clock (RxC)

The Receive Clock, when acting as an output, can drive a single TTL level load. As an input, it must be driven by at least one TTL level load.

Transmit Data (TxD)

The Transmit Data output is capable of driving a single TTL level load.

Other Outputs (RTS, DTR)

The remaining outputs are each buffered by a TTL buffer, thus each of them will drive ten TTL level loads.

Five volt source (+5)

The five volt source is regulated DC, capable of supplying 100 mA worst case.

Nine volt source (+9)

The nine volt source is an unregulated nine volt (RMS) supply, capable of supplying a worst case current of 400 DC mA.

7.4 TIMING

PARAMETER	SYMBOL	MIN	MAX	UNIT
Transmit/Receive Clock Rate	T_{ccy}	400	-	ns
Transmit/Receive Clock High Time	T_{ch}	175	-	ns
Transmit/Receive Clock Low Time	T_{cl}	175	-	ns
XTAL1 to TxD Propagation Delay	T_{dd}	-	500	ns
Propagation Delay (/RTS, /DTR)	T_{dly}	-	500	ns
/IRQ Propagation Delay (Clear)	T_{ira}	-	500	ns

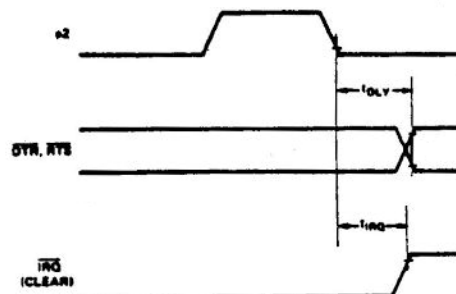

Interrupt and Output Timing

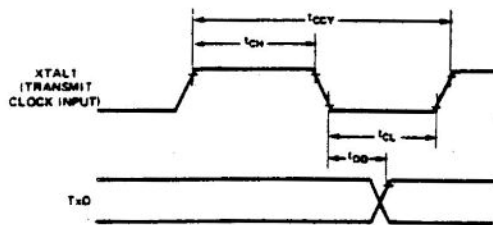

NOTE: Tx0 rate is 1/16 TxC rate.

Transmit Timing with External Clock

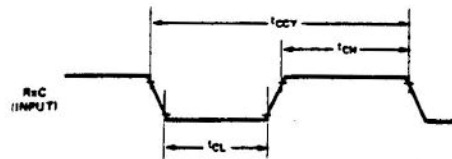

NOTE: RxD rate is 1/16 RxC rate.

Receive External Clock Timing

o551, 6529 TIMING

PARAMETER	SYMBOL	MIN	MAX	UNIT
PHI 2 PW	PW02	248	350	ns
ADDRESS SET UP TIME	TACR TACW	72	-	ns
ADDRESS HOLD	TCAH TCAR	25	-	ns
R/W SETUP	TWCW TWCR	71	-	ns
R/W HOLD	TCWH TWCR	93	-	ns
DATA BUS SETUP	TDCW	148	-	ns
READ ACCESS	TCDR	195	-	ns
READ DATA HOLD	THR	35	-	ns

Write Cycle

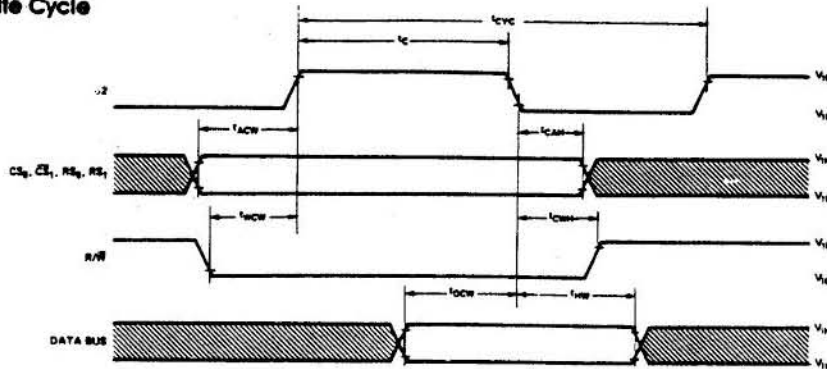

Read Cycle

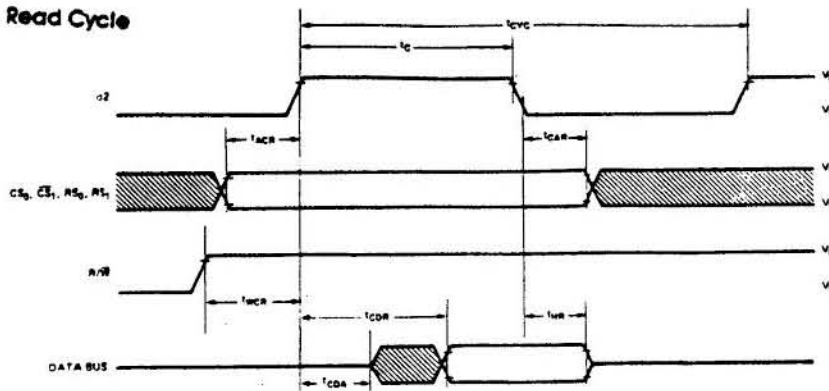

PRODUCT TERM														ACTIVE LEVEL										
INPUT VARIABLE														H	H	L	L	L	L	H	L			
N	:													:										
U	1	1	1	1	1	1	:	:	:	:	:	:	:	:	OUTPUT FUNCTION									
M	5	4	3	2	1	0	9	8	7	6	5	4	3	2	1	0	7	6	5	4	3	2	1	0
0	-	-	-	-	-	-	H	-	-	-	-	-	-	-	-	A
1	L	-	-	-	-	-	-	-	-	-	-	-	-	H	H	A	A	.	.
2	-	H	H	H	L	H	H	-	H	L	L	L	L	H	H	-	A	.	.	.
3	L	H	H	H	L	H	H	-	H	L	L	L	H	H	H	H	A	.	.
4	L	H	H	H	L	H	H	-	H	L	L	H	H	H	H	H	.	.	A
5	-	H	H	H	L	L	H	-	H	-	-	-	-	H	-	-	.	A
6	L	H	H	H	L	H	H	-	H	H	H	L	H	H	H	H	.	.	.	A
7	L	H	H	H	L	H	H	-	H	L	L	H	L	H	H	-	A

```

A K K A 6 6 P S
R E E D 5 5 H P
M R Y D 5 2 I E
N P R 1 9 2 E
O
R C $ $ C H
T L F F L
K D D K $
$ 0 1 F
F $ X X D
D F 2
3 D X
X D
X
    
```

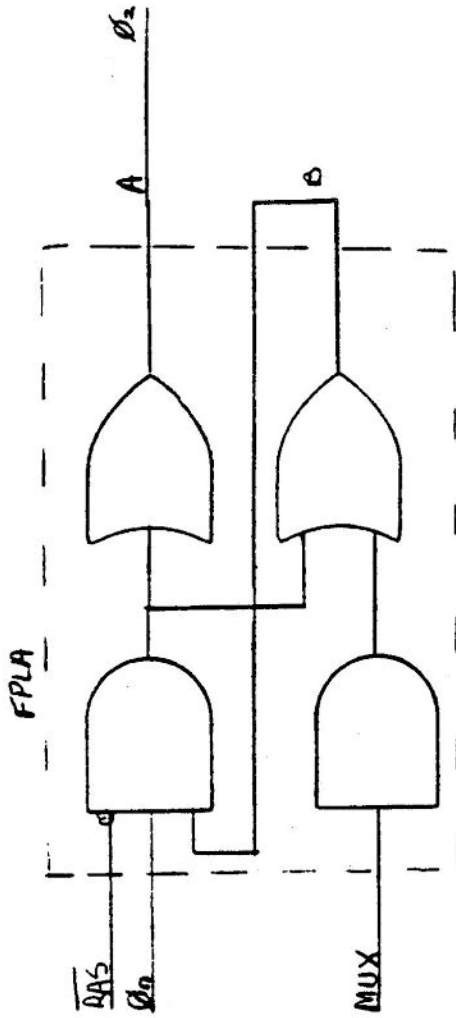
$t_{FPO} \text{ RAS} = \frac{242}{2000000}$
 RAS TO ϕ_0 DELAY $\frac{17}{42}$ TO 7700 Td R. ϕ_2 L
 RAS TO ϕ_2 DELAY $\frac{17}{42}$ TO 7700 Td R. CS L
 ϕ_0 TO CS DELAY $\frac{11}{42}$ TO 7700 Td ϕ_0 ϕ_2 L
 ϕ_2 TO ϕ_0 DELAY $\frac{11}{42}$ TO 7700 Td ϕ_0 ϕ_2 L

7.7 TED PHI 2 GENERATION

PLA INTERNAL LOGIC

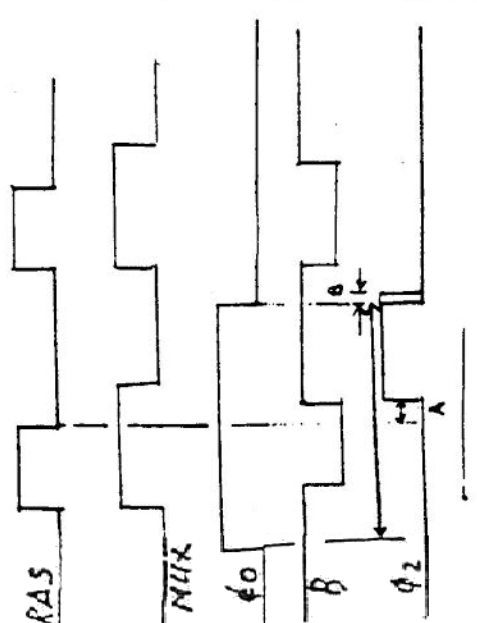

UNLESS OTHERWISE SPECIFIED		DRAWN BY:		DATE	
TOLERANCES ON:		CHKD:			
DECIMALS		ENGR:			
.X .XX .XXX <'S		APPR:			
.X .XX .XXX <'S		USED ON		NEXT ASSY	
MATERIAL:					
FINISH:					
commodore				SIZE	
64 K TED				REV	
64 CLOCKS				SCALE	
				SHEET	
				OF	

8. THE VIDEO SECTION

8.1 VIDEO INTERFACE

The TED video interface hardware allows the connection of a standard NTSC or PAL commercial television and/or a color monitor. The monitor may accept either a composite video signal or separate chroma and luminance/sync signals in addition to an audio signal.

8.2 MODULATOR SPECIFICATIONS

The modulator provides a broadcast type RF signal carrying the composite video and audio signals. The NTSC modulator is switchable between channels 3 and 4 to help minimize local broadcast interference. The signal generated by the RF modulator complies with FCC rulings concerning FCC Class B, TV Interface Devices.

8.3 MONITOR OUTPUT

The monitor output provides the following signals:

Luminance/Sync	1 V p-p	75 ohms
Chroma	1 V p-p	75 ohms
Audio	1 V p-p	
Composite	1 V p-p	75 ohms

VIDEO CONNECTOR PINOUT

The video connector provides the following signals:

PIN	SIGNAL
---	-----
1	Luminance/Sync
2	Ground
3	Audio Out
4	Composite
5	Audio In
6	Chroma
7	N.C.
8	N.C.

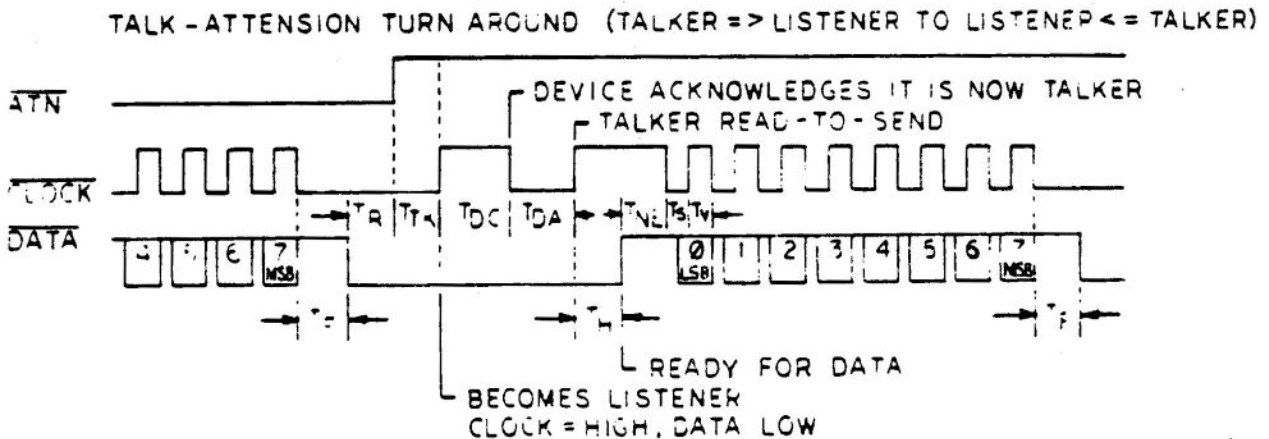
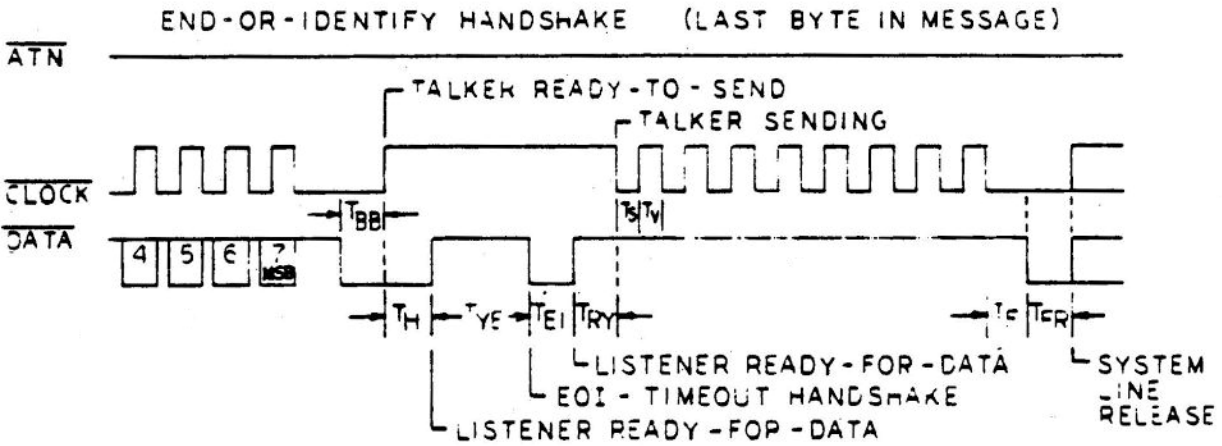
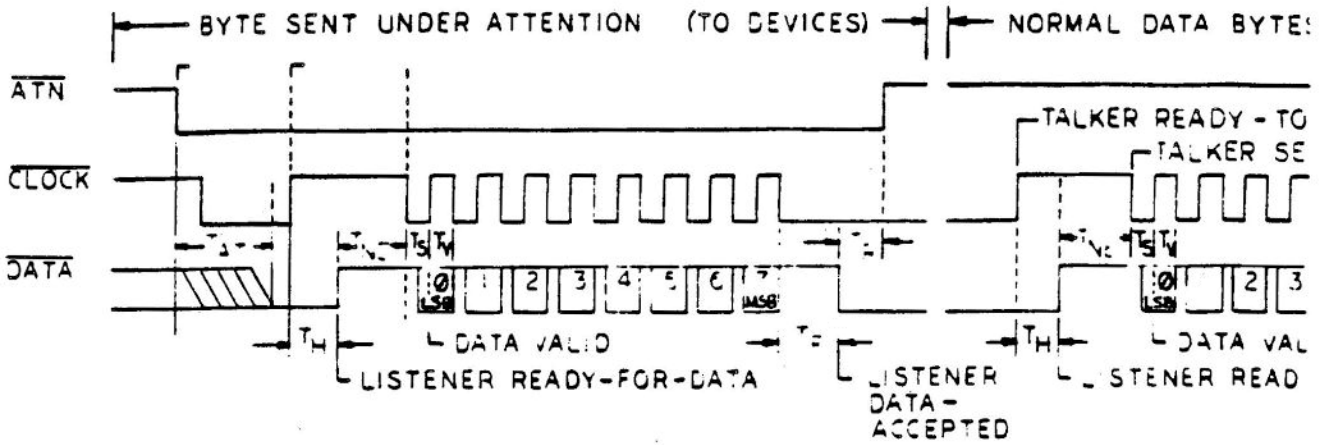

Pin	Type
1	SERIAL SRQIN
2	GND
3	SERIAL ATN IN/OUT
4	SERIAL CLK IN/OUT
5	SERIAL DATA IN/OUT
6	RESET

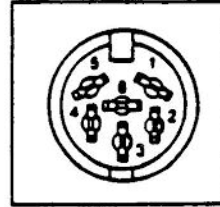

10. THE EXPANSION BUS

10.1 EXPANSION BUS PINOUT

PIN	NAME	PIN	NAME
1	GND	A	GND
2	+5	B	C1LOW
3	+5	C	/BRESET
4	/IRQ	D	/RAS
5	R/W	E	PHIO
6	CIHI	F	A15
7	C2LOW(reserved)	H	A14
8	C2HI(reserved)	J	A13
9	/CS1	K	A12
10	/CS0	L	A11
11	/CAS	M	A10
12	MUX	N	A9
13	BA	P	A8
14	D7	R	A7
15	D6	S	A6
16	D5	T	A5
17	D4	U	A4
18	D3	V	A3
19	D2	W	A2
20	D1	X	A1
21	D0	Y	A0
22	AEC	Z	NC
23	EXT AUDIO	AA	NC
24	PHI 2	BB	NC
25	GND	CC	GND

10.2 EXPANSION CONNECTOR SIGNAL DESCRIPTION

A0 - A15	SYSTEM ADDRESS BUS - UNBUFFERED. OUTPUT.
D0 - D7	SYSTEM DATA BUS -UNBUFFERED. OUTPUT.
/CS0,/CS1	INTERNAL ROM CHIP SELECTS. OUTPUT.
C1LOW,C1HI	EXTERNAL CARTRIDGE CHIP SELECTS. ACTIVE LOW. OUTPUT.
/RAS	DRAM ROW ADDRESS STROBE. OUTPUT.
MUX	DRAM ADDRESS MULTIPLEX CONTROL SIGNAL. OUTPUT.
/CAS	DRAM COLUMN ADDRESS STROBE. OUTPUT.
BA	BUS AVAILABLE. LOW FOR DMA. OUTPUT ONLY.
PHI 2	ARTIFICIAL PHI 2. ADDRESS VALID RISING EDGE. DATA VALID FALLING EDGE. OUTPUT.
R/W	SYSTEM READ WRITE LINE. OUTPUT.
/IRQ	INTERUPT REQUEST. INPUT.
/BRESET	BUFFERED RESET. OUTPUT.
EXT AUDIO	EXTERNAL AUDIO. INPUT. 1 V P-P FULL SCALE. AC COUPLED.

11. READ ONLY MEMORY

11.1 SYSTEM ROM DESCRIPTION

In a basic configuration, the TED operating system resides in 32K of read only memory contained in two 16K X 8 ROM. The KERNAL resides in the upper 16K ROM (referred to as HIGH ROM) and some of the lower 16K ROM (LOW ROM). The Kernal, by definition, is the operating system of the computer, with fixed entry points into usable subroutines to facilitate use by higher level programs. The entry table for the Kernal is located above the 7360 in memory. (\$FF40 - \$FFF9) Contained in the space allocated for the Kernal is the character ROM at location \$D000 - \$D7FF. 'BASIC' is contained in the lower ROM not used by the Kernal.

11.2 BANKING ROM OPERATION

Although the system can only 'see' 32K of ROM at a time, up to 64K can be installed on board, with an additional 32K on as external cartridge. This is possible using the scheme known as 'banking'. Banking is accomplished by writting to thee address range of \$FDD0 - \$FDDF. When a write to this address range occurs, the lower four bits of the address bus select 2 of 8 banks (each 16K). Refer to the chart below.

A0	A1	BANK
0	0	low internal #1, 'BASIC'
0	1	low internal #2, 'FUNCTION LOW'
1	0	low external #1, 'CARTRIDGE LOW'
1	1	reserved

A2	A3	BANK
0	0	hi internal #1, 'KERNAL'
0	1	hi internal #2, 'FUNCTION HI'
1	0	hi external #1, 'CARTRIDGE HI'
1	1	reserved

Even when the Kernal is banked out, part of the Kernal remains accessable. This is the part of the Kernal that does the actual banking and is loacted in the address range of \$FC00 to \$FCFF. This section of ROM will not assert itself if ROM is banked out for RAM.

11.3 ROM ELECTRICAL SPEC

Absolute Maximum Ratings

INPUT VOLTAGE (V_{in})	-0.5V to +7.0 VDC
SUPPLY VOLTAGE (V_{cc})	-0.5V to +7.0 VDC
OPERATING TEMP (T_a)	0 to 70 °C
STORAGE TEMP	-55 to 150 °C

D.C. Characteristics

INPUT LEAKAGE CURRENT	-10 μ A
DYNAMIC CHARACTERISTICS	$V_{cc} = 5.0V \pm 5\%$
INPUT HIGH VOLTAGE (V_{IH})	$V_{ss} + 2.4V$ to $V_{cc} + 1V$
INPUT LOW VOLTAGE (V_{IL})	$V_{SS} - 0.5V$ to $V_{ss} + 0.8V$
OUTPUT HIGH VOLTAGE (V_{OH})	$V_{SS} + 2.4V$
($I_{OH} = -200\mu A$ $V_{CC} = 4.75VDC$)	
OUTPUT LOW VOLTAGE (V_{OL})	$V_{SS} + 0.4V$
($I_{OL} = -3.2mA$ $V_{CC} = 5.25V$)	
MAX POWER SUPPLY CURRENT	120 mA

11.4 23128 ROM PINOUT

PIN	NAME	DESCRIPTION
1	NC	
2	A12	ADDRESS BIT 12
3	A7	ADDRESS BIT 7
4	A6	ADDRESS BIT 6
5	A5	ADDRESS BIT 5
6	A4	ADDRESS BIT 4
7	A3	ADDRESS BIT 3
8	A2	ADDRESS BIT 2
9	A1	ADDRESS BIT 1
10	A0	ADDRESS BIT 0
11	D0	DATA BIT 0
12	D1	DATA BIT 1
13	D2	DATA BIT 2
14	GND	POWER SUPPLY GROUND
15	D3	DATA BIT 3
16	D4	DATA BIT 4
17	D5	DATA BIT 5
18	D6	DATA BIT 6
19	D7	DATA BIT 7
20	/CS	CHIP SELECT / ACTIVE LOW
21	A10	ADDRESS BIT 10
22	/CE	CHIP ENABLE / ACTIVE LOW
23	A11	ADDRESS BIT 11
24	A9	ADDRESS BIT 9
25	A8	ADDRESS BIT 8
26	A13	ADDRESS BIT 13
27	CS or CE	CHIP SELECT OR CHIP ENABLE / ACTIVE HIGH
28	VCC	POWER SUPPLY +5

11.5 ROM TIMING SPECIFICATION

PARAMETER	SYMBOL	MIN.	MAX.	
ACCESS TIME	TACC	300	-	ns
OUTPUT ENABLE	TOE	120	-	ns

Note: TACC available from system is 338ns and TOE available is 120ns.

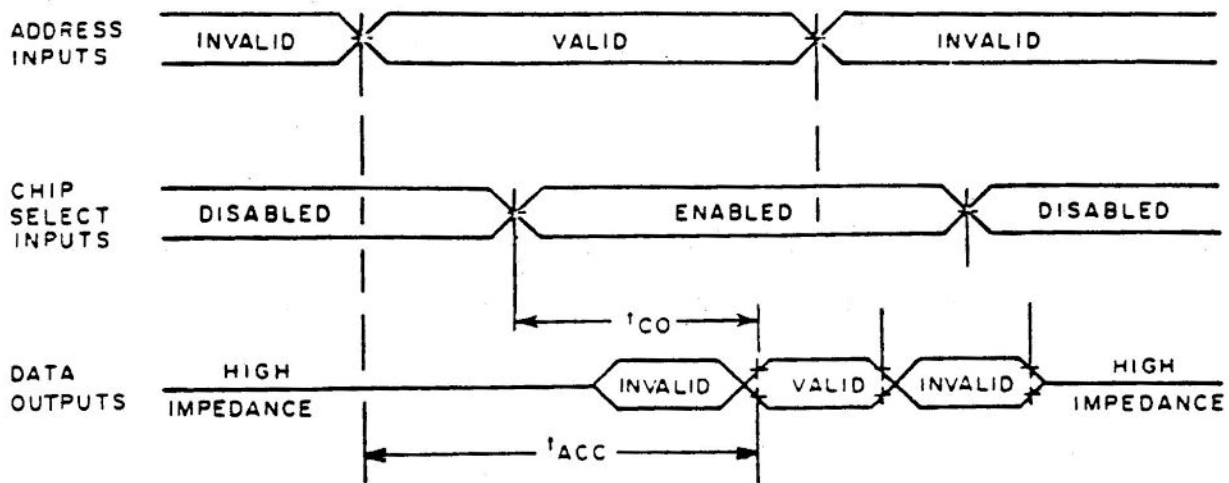

12. THE KEYBOARD

12.1 KEYBOARD CONNECTOR PINOUT

PIN	NAME	DESCRIPTION
1	D5	DATA BIT 5
2	K7	KEY LATCH BIT 7
3	GND	LED GND
4	+5V	LED +5VOLT 20ma MAX.
5	D7	DATA BIT 7
6	K4	KEY LATCH BIT 4
7	D1	DATA BIT 1
8	K5	KEY LATCH BIT 5
9	K6	KEY LATCH BIT 6
10	D3	DATA BIT 3
11	D2	DATA BIT 2
12	D4	DATA BIT 4
13	K2	KEY LATCH BIT 2
14	K1	KEY LATCH BIT 1
15	D6	DATA BIT 6
16	K3	KEY LATCH BIT 3
17	K0	KEY LATCH BIT 0
18	D0	DATA BIT 0

12.2 KEYBOARD MATRIX

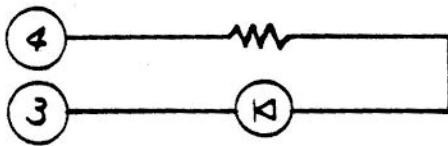
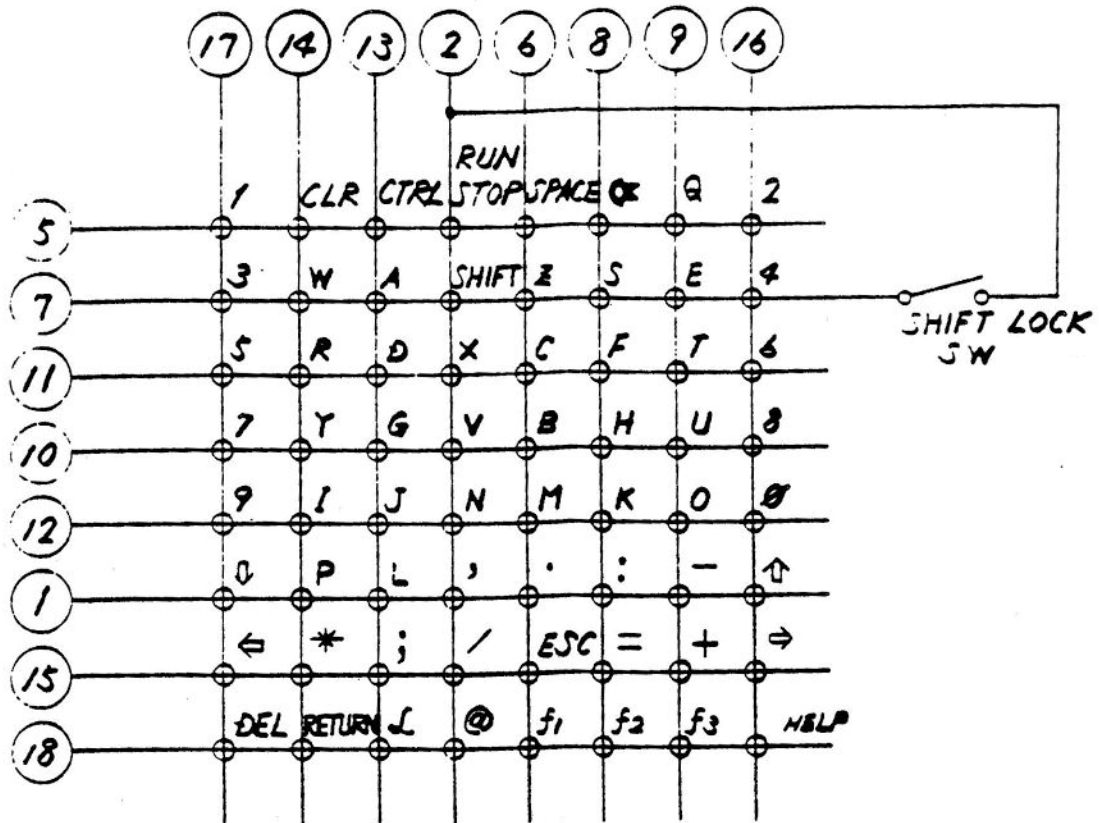

KEY MATRIX

12.3 KEYBOARD ELECTRICAL SPECIFICATION

1) MAXIMUM RATING	12VDC, 200 μ S PULSE WIDTH 1/50 DUTY CYCLE 1ma
2) CHATTERING	5mSEC INITIAL, 10mSEC OVER LIFE
3) CONTACT RESISTANCE	500 OHM MAX.
4) CAPACITANCE	100pf MAX
5) INSULATION RES.	50M OHM MIN.
6) WITHSTAND VOLTAGE	250VAC 1min.
7) OPERATING FORCE	65g TYP.
	ZERO TRAV FORCE 15+/-10g AT .5mm TRAV
	FULL TRAV FORCE 90+/-25g AT .5mm ABOVE FULL TRAV
8) OPERATING LIFE	500 MILLION TIMES
FUNCTION KEYS	300 MILLION TIMES
9) OPERATING TEMP	-5 - +50 'C
10) STORAGE TEMP	-20 - +65'C

13. THE CIRCUIT BOARD

13.2 PARTS PLACEMENT

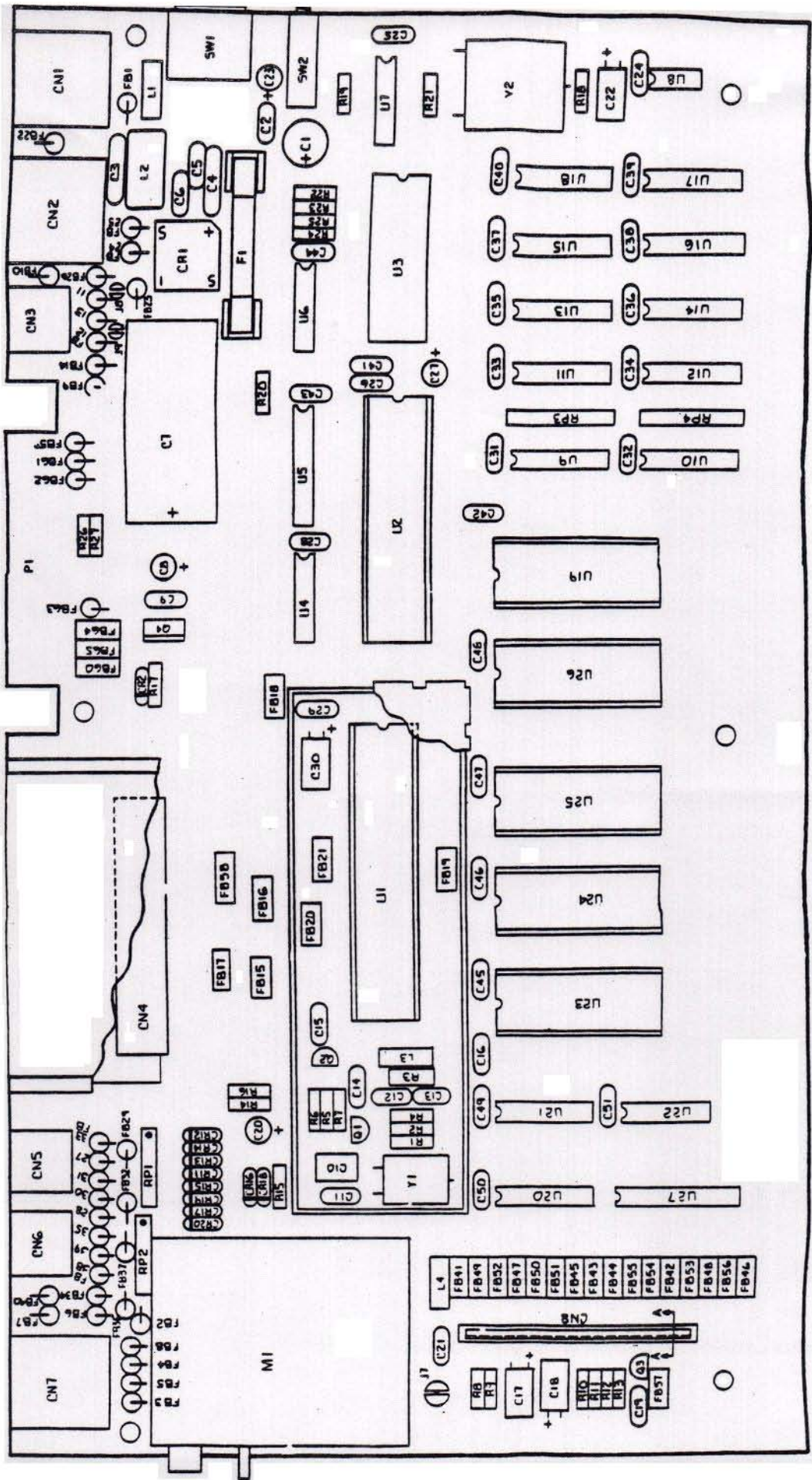

CLOCKS

PARAMETER	SYMBOL	MIN	MAX	UNT	REFERENCE SHEET	SYNONYM	EQUATION
CYCLE TIME, Single speed	TCYC _S	1117	1139	ns	A	TC _S	
CYCLE TIME, Double speed	TCYC _D	559	559	ns	A	TC _D	
Pulse width Phi Low (SS)	PW _{ΦLS}	515	585	ns	A		
Pulse width Phi High (SS)	PW _{ΦHS}	515	585	ns	A		
Pulse width Phi Low (DS)	PW _{ΦLD}	275	295	ns	A		
Pulse width Phi High (DS)	PW _{ΦHD}	260	285	ns	A		
Φ to AEL Delay	TAEC	10	40	ns	B		
PHI LOW TO RAS HI	Td _{ΦLRH}	60	110	ns	A	Td _{CoRH}	
PHI LOW TO RAS LOW	Td _{ΦLRL}	220	260	ns	A	Td _{CoRL}	
RAS HI width RAS PRECHARGE	TRP	120	200	ns	A	TRH	
RAS LOW WIDTH	TRAS	359	439	ns	A	TRL, TC _{SH}	
PHI HI TO CAS HI PHI HI TO RAS HI PHI HI TO MUX HI	Td _{ΦCH} Td _{ΦHRH} Td _{ΦMH}	60	110	ns	A	Td _{CoRH}	
PHI HI TO RAS LOW	Td _{ΦHRL}	220	260	ns	A	Td _{CoRL}	
PHI LOW TO MUX HI	Td _{ΦLMH}	60	110	ns	A	Td _{CoMH}	
PHI LOW TO MUX LOW	Td _{ΦLML}	260	290	ns	A	Td _{CoML}	
MUX HI Pulse width	TMH	120	-	ns			
MUX LOW Pulse width	TML	299	-	ns			
RAS LOW TO MUX LOW	TRML	20	-	ns	A	TRM	
MUX LOW TO CAS LOW	TMLL	35	-	ns	A	TMC	
PHI LOW TO CAS HI	Td _{ΦLCH}	60	110	ns	A	Td _{CoCH}	
CAS HI Pulse width (READ)	TC _{HR}	200	-	ns	A	TC _{H(READ)}	
CAS HI Pulse width (WRITE)	TC _{HW}	275	-	ns		TC _{H(WRITE)}	
PHI LOW TO CAS LOW (READ)	Td _{ΦCLR}	300	365	ns	A	Td _{CoCL}	
CAS LOW TO PHI HI READ	Td _{CLΦRH}	205	-	ns	A		
CAS LOW TO PHI HI WRITE	Td _{CLΦRH}	75	-	ns	A		
RAS LOW TO CAS LOW	TRCD	75	-	ns	A	TRC, Td _{CLL}	
CAS HI TO RAS LOW CAS TO RAS PRECHARGE	TCRP	120	-	ns	A		TCRP = TRP
PHI HI DOUBLE SPEED TO CAS (WRITE)	TWCS	130	-	ns			
RAS LOW TO PHI HI	Td _{RLΦH}	240	-	ns			
RAS LOW TO PHI LOW	Td _{RLΦL}	290	-	ns			
RAS LOW TO PHI LOW DOUBLE SPEED	Td _{RLΦLD}	250	-	ns			
CAS LOW TO PHI LOW READ Double speed	Td _{CLΦRD}	185	-	ns			
CAS LOW TO PHI LOW WRITE Double speed	Td _{CLΦWD}	88	-	ns			
CAS LOW TO PHI LOW (READ)	Td _{CLΦR}	205	-	ns			
CAS LOW TO PHI LOW (WRITE)	Td _{CLΦW}	75	-	ns			
CAS LOW pulse width (WRITE)	TCASW	148	-	ns			
CAS LOW pulse width (READ)	TCASR	219	-	ns			
RAE LOW TO PHI2 HI	Td _{RLΦ2H}	17	42	ns			TP 1700
RAS LOW TO CS	Td _{RLCS}	17	42	ns			TP 1700
PHI LOW TO PHI2 LOW	Td _{ΦLΦ2L}	17	42	ns			TP 1700
PHI LOW TO CS HI	Td _{ΦLCS}	17	42	ns			TP 1700
PHI HI TO PHI2 HI	Td _{ΦHΦ2H}	237	302	ns			Td _{ΦHRL} + Td _{ΦLΦ2H}
PHI2 PULSE WIDTH	PW _{Φ2}	260	258	ns			PW _{ΦLS} - Td _{CLΦ2} - Td _{ΦHΦ2H}
PHI HI Double speed to PHI2	Td _{ΦHΦ2H}	17	42	ns			TP 1700

NOTE: TP1700 DOES NOT
APPEAR ON THIS EQUATION

ROM

PARAMETER	SYMBOL	MIN	MAX	UNITS	COMMENT	EQUATION
Access Time (ADDRESS)	ROM TACC	-	335	ns		$PWDL - TADS - TOSU$
Access Time (chip select)	TDE	-	118	ns	TCO	$PWDL - TCS_{50} - T_{74V5139} - TOSU$ MARGIN -2

6551A TIMING

DOC D

PARAMETER	SIGNAL	MIN	MAX	UNIT	REMARKS	SYNONYM	EQUATION
CLOCK CYCLE TIME	TCYC	558	1118	NS		TCYCS, TCYCD	
Φ ₂ PULSE WIDTH	PWΦ ₂	460	390	NS	CLOCKS	Tc	$PW\Phi_2 \approx Tc \cdot \Phi_2$
ADDRESS SETUP TIME	TACW 6551 TASR	87	-	NS		TACW	$Td\Phi_1\Phi_2H - TADS - TPT700$
ADDR. HOLD TIME	TCAH 6551 TCAH	-2	-	NS	CLKS, 7501	TCAH	$Td\Phi_1\Phi_2L$ * NEG MARGINAL
R/W SET-UP TIME	TWCW TWCR	87	-	NS	CLKS, 7501		$Td\Phi_1\Phi_2L - TRWS$
R/W HOLD TIME	TCHH TCHH	93	-	NS	CLKS, 7501		$Td\Phi_1\Phi_2H + TCHH$
DATA SETUP TIME	TOCW	197	-	NS	CLKS, 7501		$PW\Phi_1L - Td\Phi_1\Phi_2L - TDCS$
READ ACCESS TIME	TCOR	178	-	NS	CLKS, 7501		$TdR\Phi_2L - TdR\Phi_2H - TRWS$
READ DATA HOLD	THR	37	-	NS			$Td\Phi_1\Phi_2L + THR 6551$ * NEG MARGINAL
DOUBLE SPEED							
Φ ₂ PULSE WIDTH	PWΦ ₂	≈ 274					$PW\Phi_2H \approx Tc + TPT700 - TPT700$
ADDR SETUP TIME	TACW 6551 TASR	141					$PW\Phi_2L - TADS + TPT700$
ADDR HOLD TIME	TCAH 6551 TCAH	-2					* NEG MARGINAL
R/W SET UP TIME	TWCW TWCR	108					$PW\Phi_2L - TRWS + TPT700$
R/W HOLD		93					
DATA SETUP	TOCW	61					
READ ACCESS	TCOR	178					$PW\Phi_2L - TPT700(MAX) - TDSU 6510$
READ DATA HOLD	THR	37					

DRAMS

DOC F

PARAMETER	SYMBOL	REFERENCE			SYNONYM	EQUATION	
		MIN	MAX	UNIT SHEET			
RANDOM CYCLE TIME	TRC	558	1118	NS	CLOCKS	TRCS, TCYCD	T_{CYCS}
ACCESS TIME F/RAS	TRAC	-	20				$T_{DQZ} - T_{OSU}$ (WE F. 12.11.13)
ACCESS TIME F/CAS	TCAC	-	115				T_{CAC} SPEED'D BY TED'S NEG MARGIN X TO BE ADDRESSED BY NEXT REV TEL
TURN OFF DELAY	T _{OFF}	0	40	NS			SEE DRAM DATA SHEET, APPROX only
RAS PRECHARGE TIME	TRP	120	-	NS	CLOCKS	TRH	$T_{RP} = T_{RH}$
RAS PULSE WIDTH	TRAS	359	-	NS	CLOCKS	TRL	$T_{RAS} = T_{RL}$
RAS HOLD TIME (READ)	TRSHR	279	-	NS		TCL	$T_{DQZRH} = T_{DQZCH}, T_{RSHR} = T_{CASR}$
RAS HOLD TIME (WRITE)	TRSHW	149	-	NS	CLOCKS	TCL, TCS	$T_{DQZRH} = T_{DQZCH}, T_{RSHW} = T_{CASW}$
CAS PULSE WIDTH (READ)	TCASR	279	-	NS	CLOCKS		(DEFINED ON CLOCKS SHEET)
CAS PULSE WIDTH (WRITE)	TCASW	149	-	NS	CLOCKS	TCL, TCS	(DEFINED ON CLOCKS SHEET)
CAS HOLD TIME	TCSH	359	-	NS	CLOCKS	TRAS, TRL	$T_{DQZRH} = T_{DQZCH}, T_{CSH} = T_{RAS}$
RAS TO CAS DELAY TIME	TRCO	75	-	NS	CLOCKS	TRC	(DEFINED ON CLOCKS SHEET)
CAS TO RAS PRECHARGE	TCRP	85	-	NS	CLOCKS		$T_{DQZRH} = T_{DQZCH}, T_{CRP} = T_{RP}$
ROW ADDR SETUP TIME	TASR	40	-				$T_{DQZRL} - T_{PLASYNTH} - T_{ADS}$
ROW ADDR HOLD TIME	TRAH	24	-	NS			$T_{DQZRL} + T_{PLAS7DEL}$
COL ADDR SET-UP	TASC	14	-	NS			$T_{DQZCL} - T_{PLAS7SEL}$
COL ADDR HOLD	TAH	115	-	NS	CLKS, 6510		$T_{DQZLW} + T_{HW}$
COL ADDR HOLD REF TO RAS	TAR	300	-	NS	CLKS, 6510		$T_{DQZLH} + T_{HW}$
READ COMMAND SET-UP	TRCS	130	-	NS	CLKS, 6510		$T_{CHA} - T_{MRWS}$
READ COMMAND HOLD	TRCH	30	-	NS	6510		T_{MRWH}
WRITE COMMAND HOLD	TWCH	179	-	NS	CLKS, 6510		$T_{CAS} + T_{MRWH}$
WRITE COM HOLD REF TO RAS	TWCR	359	-	NS	CLKS, 6510		$T_{RAS} + T_{MRWH}$
WRITE COMMAND PULSE WIDTH	TWP	505	-	NS	CLKS, 6510		$T_{DQZS} - T_{MRWS} + T_{MRWH}$
WRITE COM TO CAS LEAD	TWCL	475	-	NS	CLKS, 6510		$T_{DQZS} - T_{MRWS}$
DATA-IN SETUP TIME	TDS	80	-	NS	CLKS, 6510		$T_{DQZS} - T_{DQZS} (DS), T_{DQZS} - T_{DQZS}$
DATA-IN HOLD TIME	T _{DH}	135	-	NS	CLKS, 6510		$T_{DQZL} + T_{HW}$
DATA-IN HOLD REF TO RAS	T _{DHR}	350	-	NS	CLKS, 6510		$T_{DQZL} + T_{HW}$
REFRESH PERIOD	TREF	-	>2	MS			
WRITE COM SETUP	TWCS	205	-	NS	CLKS, 6510		$T_{CHW} - T_{MRWS}$
CAS TO WE DELAY	T _{CWD}	NA	-		NA		NA
RAS TO WE DELAY	T _{RWD}	NA	-		NA		NA
RAS PRECHARGE TO CAS HOLD	T _{RPC}	ND	-		NA		NA