

REVISIONS

LTR	ZONE	DESCRIPTION	DATE	APPROVED
B		REDRAWN & REVISED PER ECO 910309 REV 5 PCB	8-29-91	R. BUCKS

UNLESS OTHERWISE SPECIFIED		DRAWN BY: G. BERLIN		DATE		commodore	
TOLERANCES ON:		CHKD:				SCHEMATIC	
DECIMALS		ENGR:				C65 PCB ASSY	
.X	.XX	.XXX	<'S	APPR:			
±	±	±	±				
MATERIAL:		USED ON	NEXT ASSY				
FINISH:		C65	313365		SIZE		
					B	313366	REV B
					SCALE	SHEET 1 OF 7	

© 1991 COMMODORE ELECTRONICS LTD.

INFORMATION CONTAINED HEREIN IS THE UNPUBLISHED AND CONFIDENTIAL PROPERTY OF COMMODORE ELECTRONICS LTD. USE, REPRODUCTION OR DISCLOSURE OF THIS INFORMATION WITHOUT THE PRIOR WRITTEN PERMISSION OF COMMODORE IS STRICTLY PROHIBITED. ALL RIGHTS RESERVED.

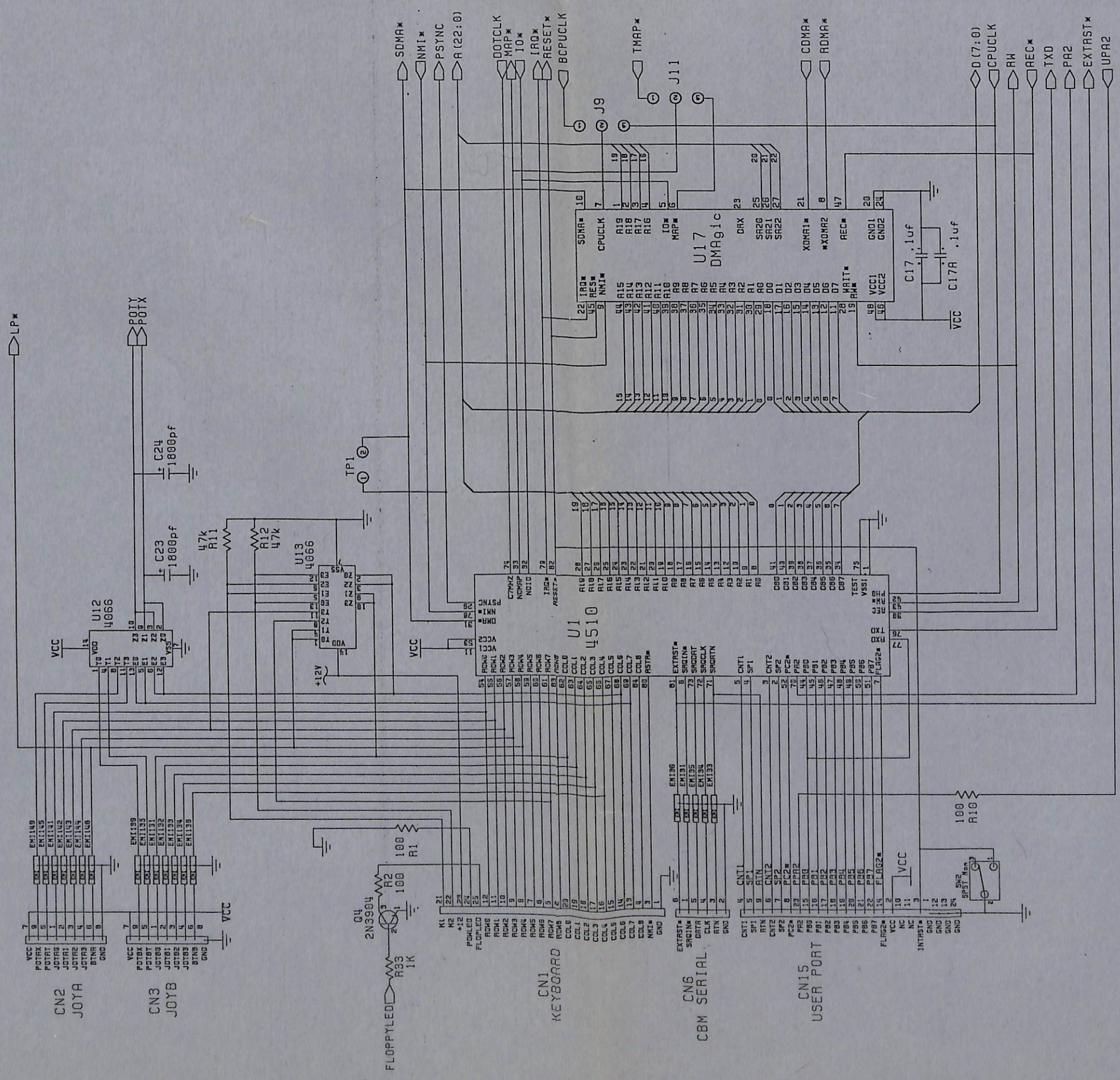

© 1988 COMMODORE BUSINESS MACHINES
 Information contained herein is the unpublished,
 confidential and trade secret property of
 Commodore Business Machines, Inc. Any use,
 without the express written permission of
 Commodore is strictly prohibited.

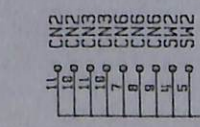
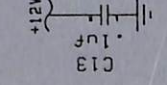
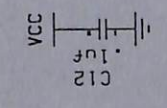
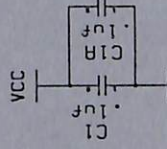

DESIGNED BY	C. BarLin	commodore
DATE	2/27/81	C65
ENGR	PAUL LASSA	CPU AND DMA
DATE APPROVED	none	3133661R3
PATRNAME	/Project/ats/r3 epu	Sheet 2 of 7

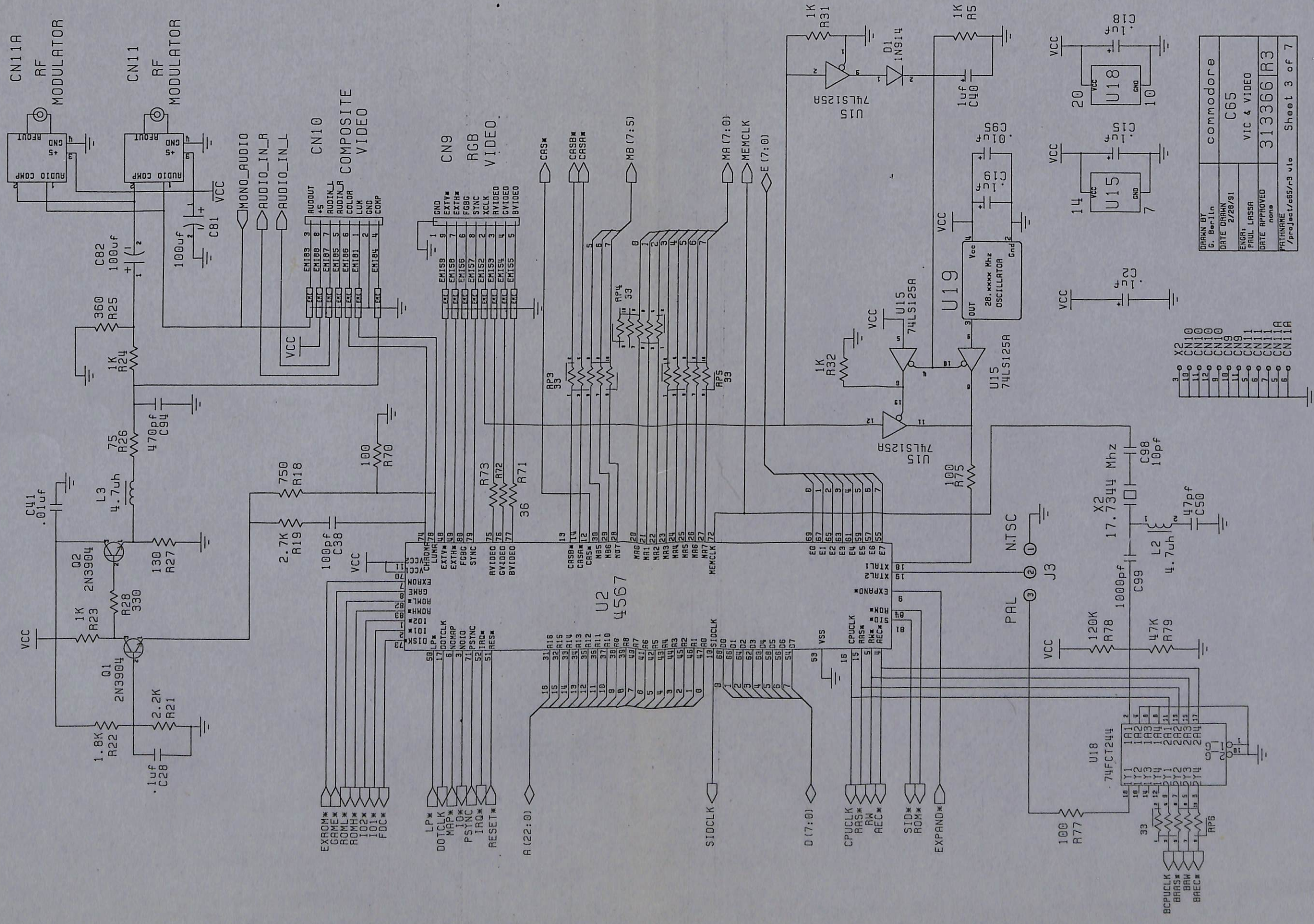

- X2
- CN10
- CN10
- CN10
- CN9
- CN9
- CN11
- CN11
- CN11
- CN11A

DESIGNED BY	G. Berlin	commodore
DATE DRAWN	2/28/91	C65
EXGR+ NAME	PAUL LASSA	VIC & VIDEO
DATE APPROVED	none	313366
PATHNAME	/projact/c65/r3 v1o	R3
		Sheet 3 of 7

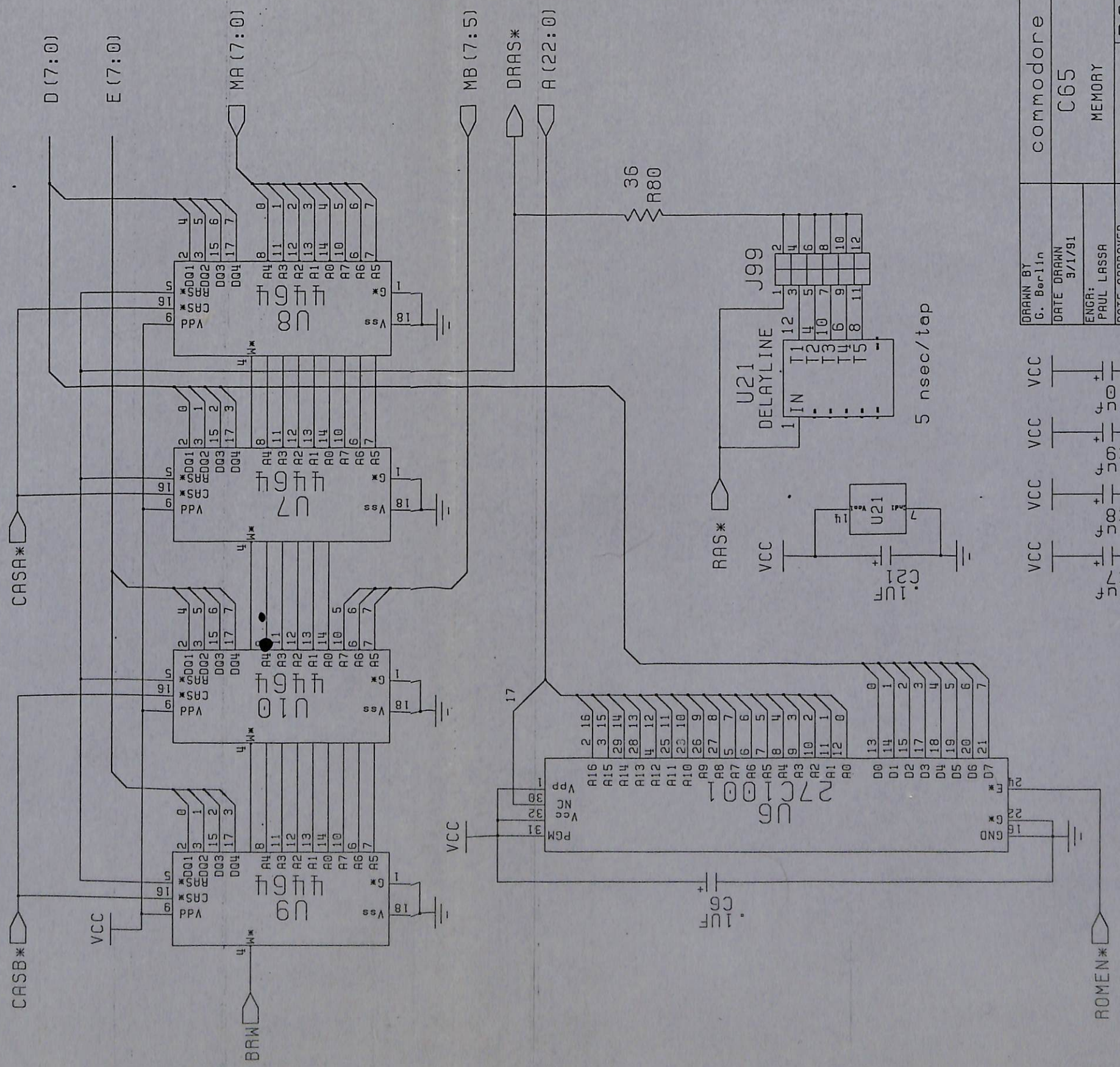

DRAWN BY	G. Berlin	commodore
DATE DRAWN	3/1/91	C65
ENGR:	PAUL LASSA	MEMORY
DATE APPROVED	none	313366 R3
PATHNAME	/project/c65/r3 memory	Sheet 4 of 7

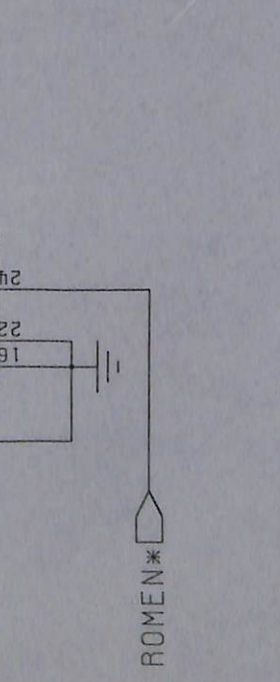
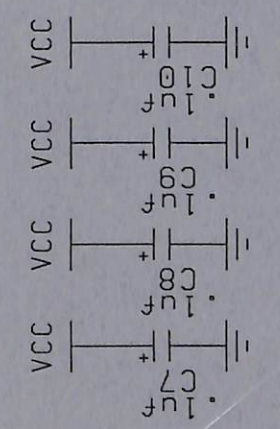

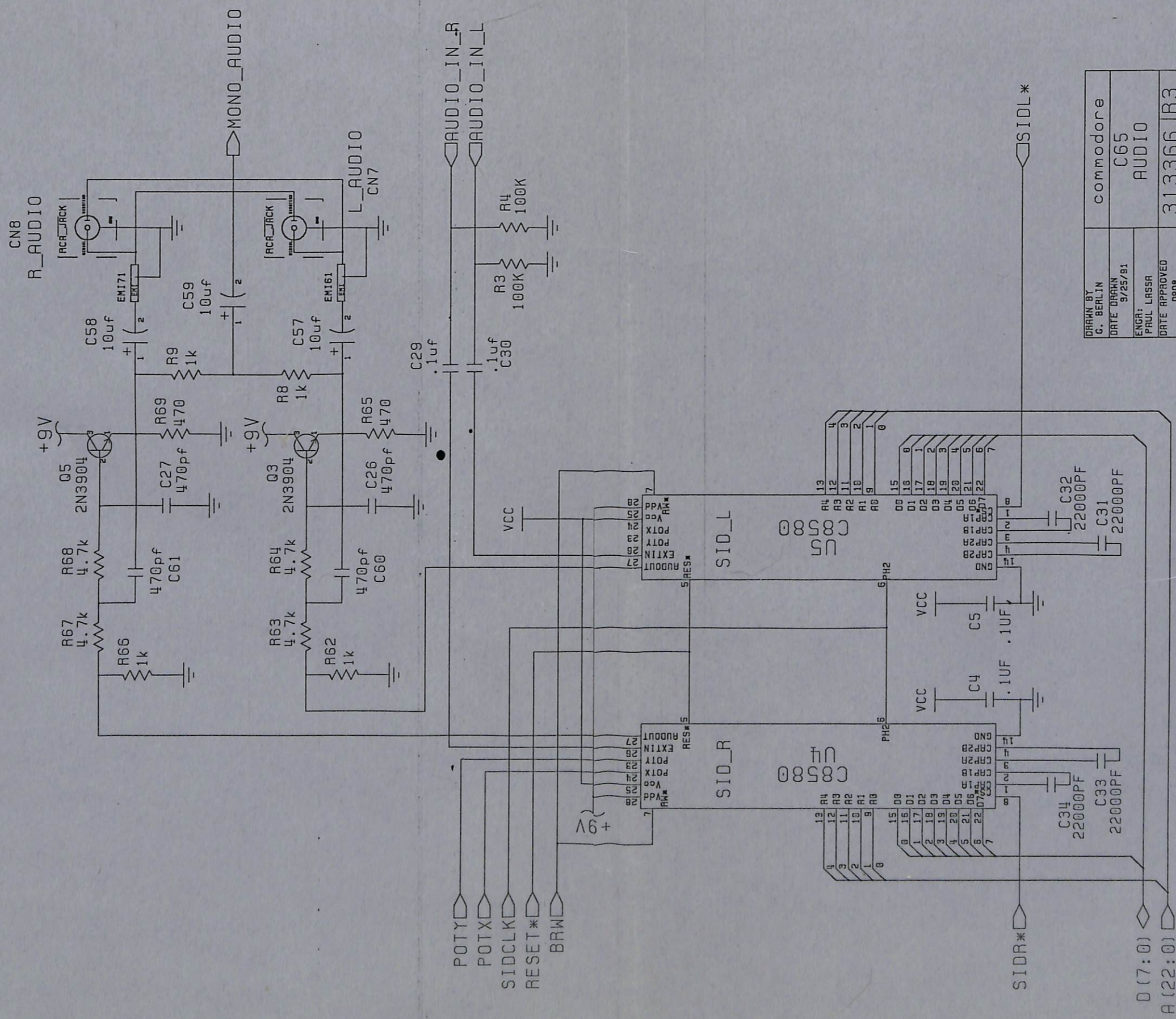

DRAWN BY	G. BERLIN	commodore
DATE DRAWN	9/25/91	C65
ENGR:	PAUL LASSA	AUDIO
DATE APPROVED	none	313366 R3
PATHNAME	/project/c65/r3 audio	Sheet 5 of 7

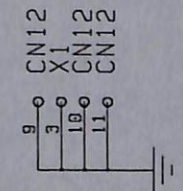
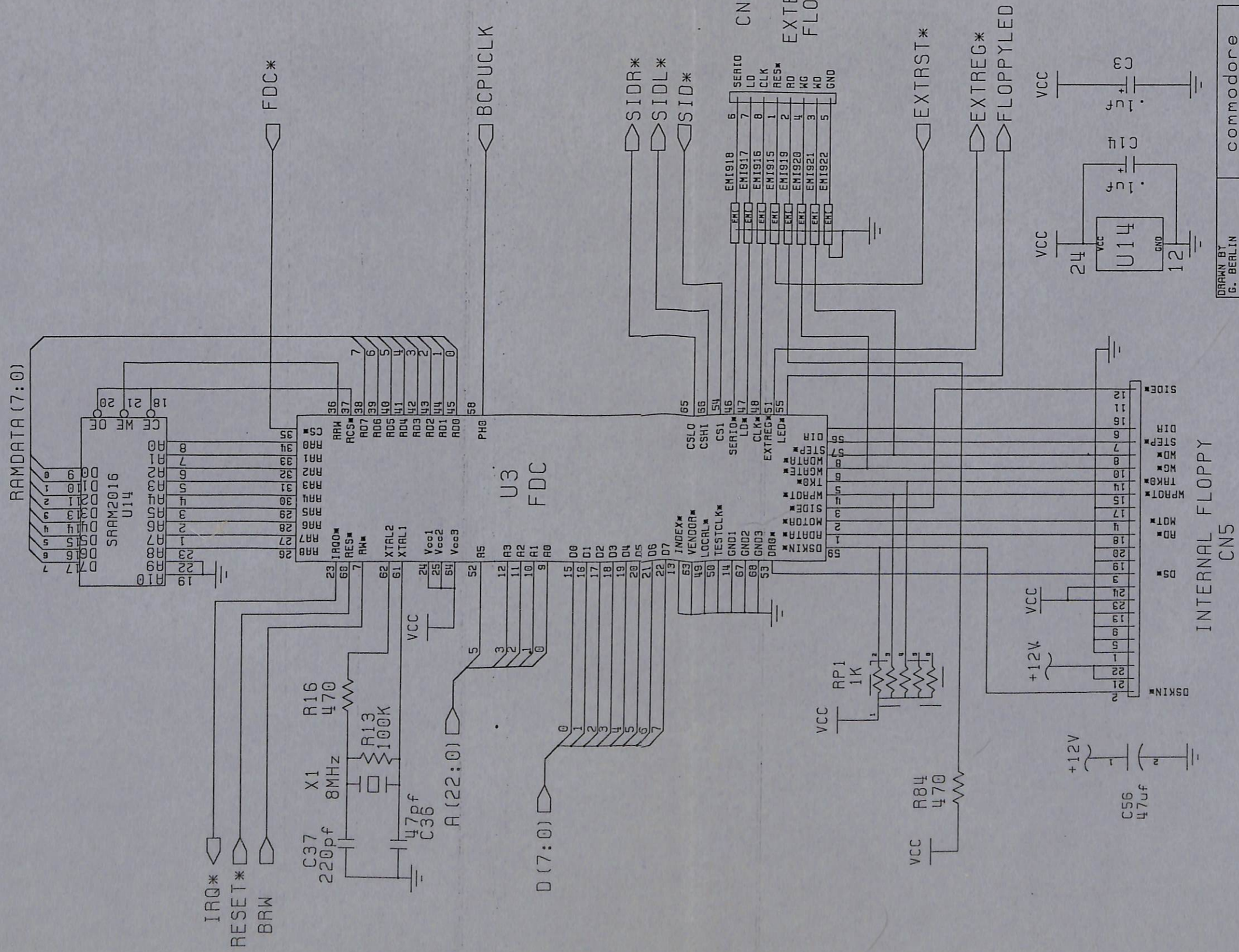

DRAWN BY G. BEALIN	commodore
DATE DRAWN 2/28/91	C65
ENGR: PAUL LASSA	Floppy Disk
DATE APPROVED none	313366/R3
PATHNAME projec1/65/r3 floppy	Sheet 6 of 7

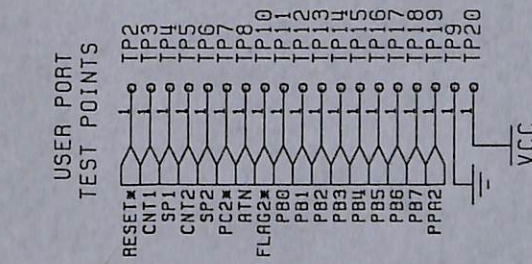
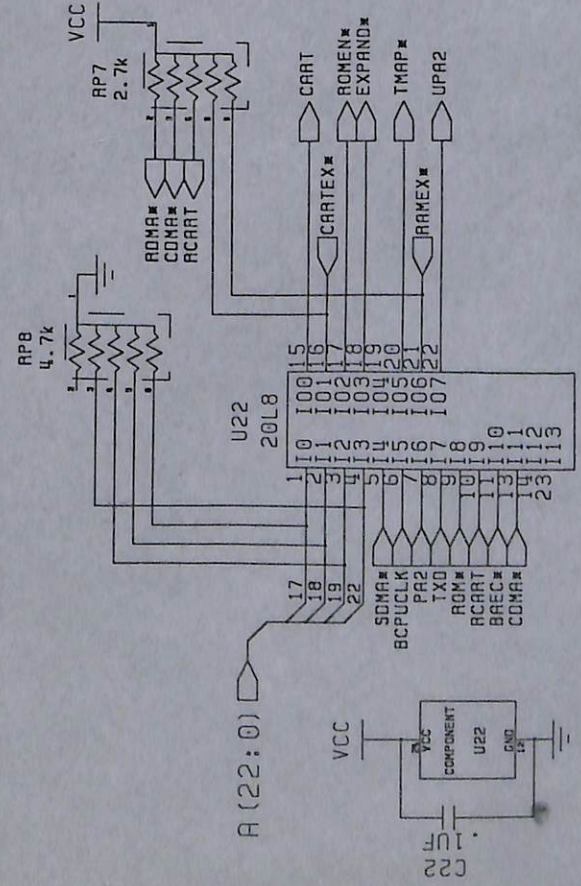
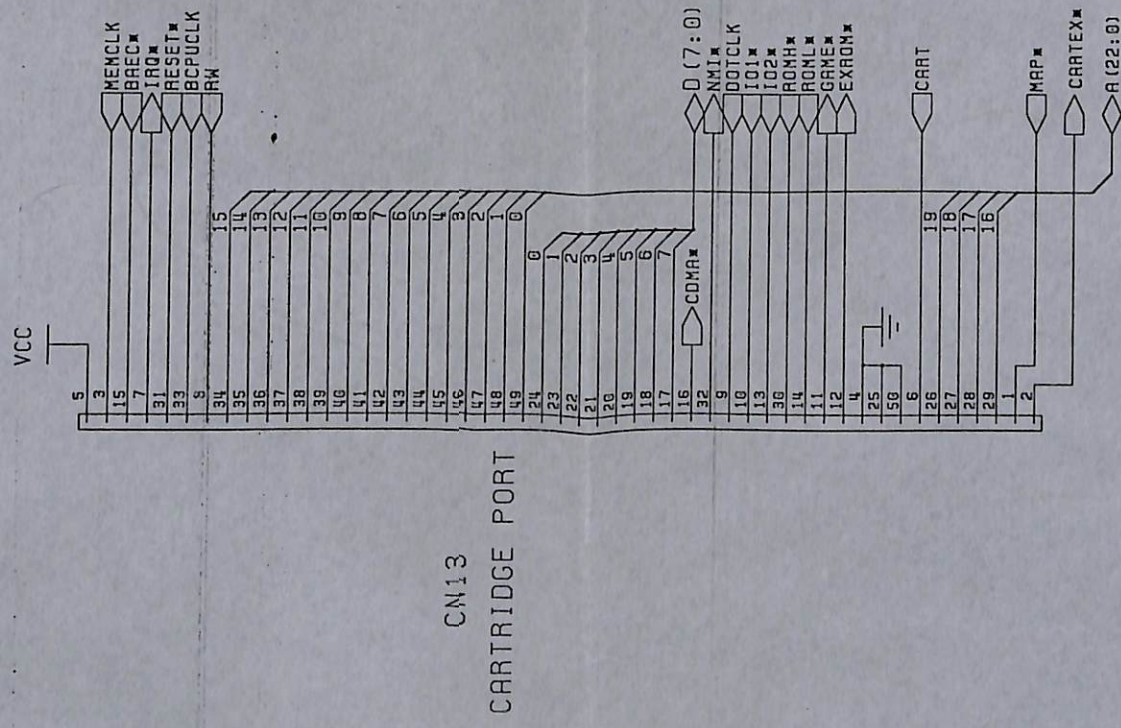
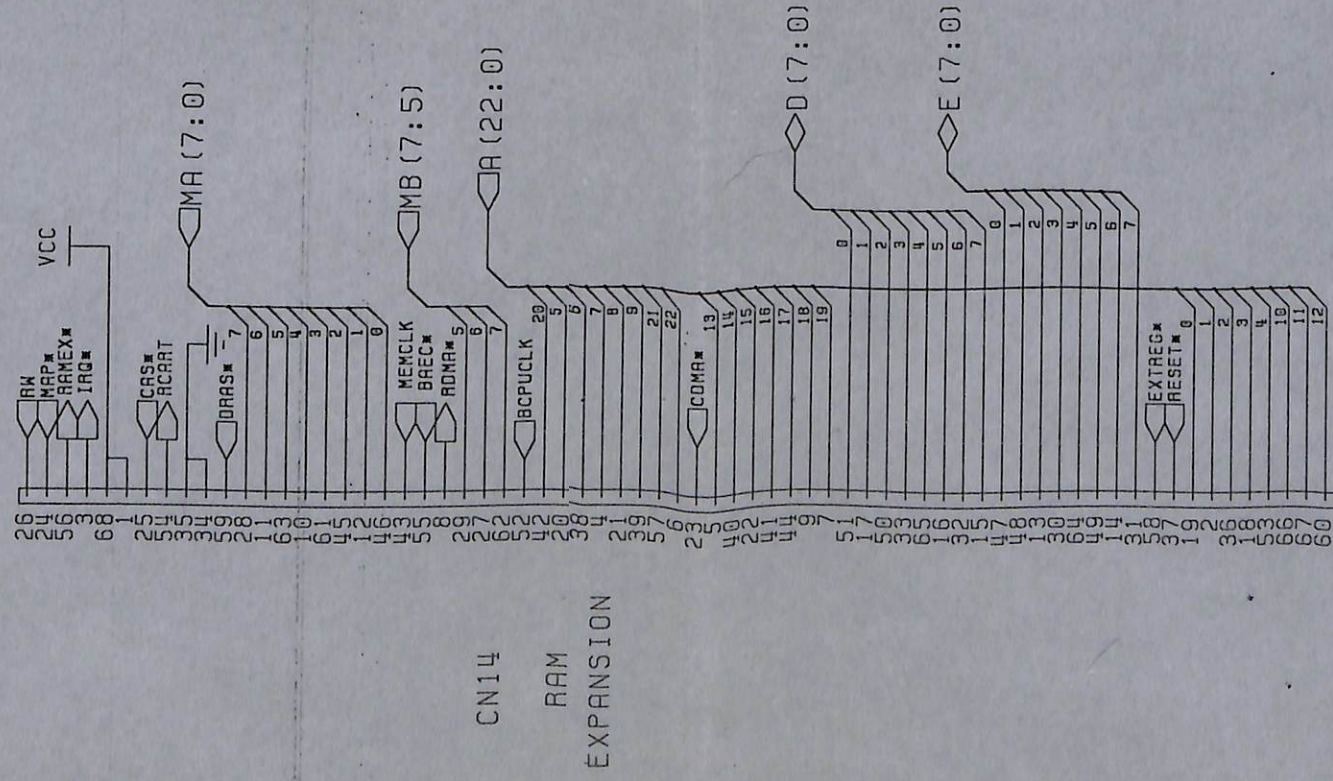
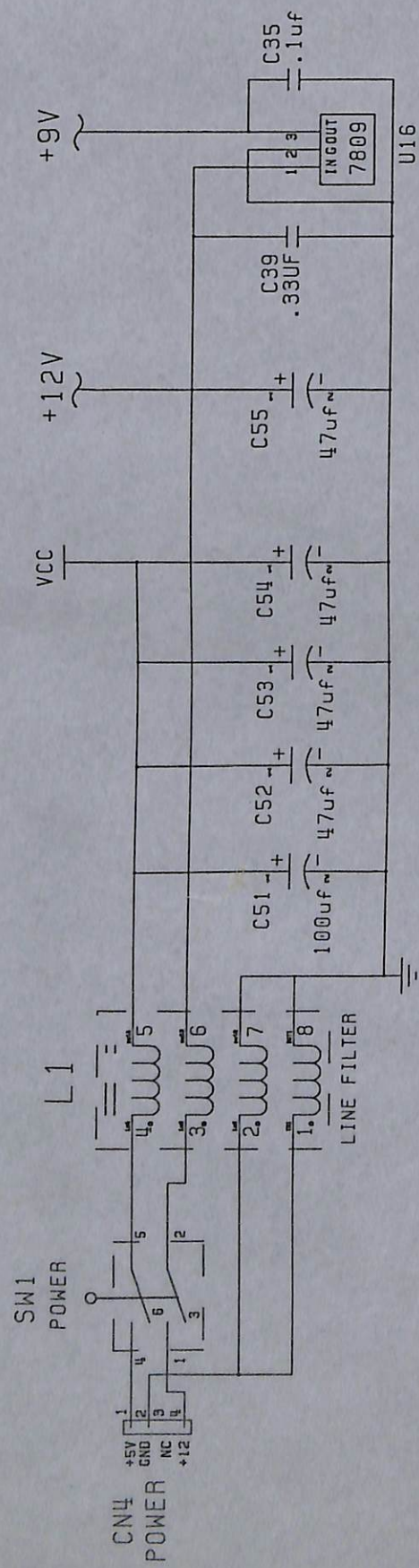

DRAWN BY	C. BerLin	commodore
DATE DRAWN	3/25/81	C65
ENGR:	PHIL LASSA	Power, PALS, etc...
DATE APPROVED	none	313366 R3
PATHNAME	/project/065/r3 nloc	Sheet 7 of 7